

# Amateur Radio Emergency Communications Training Course

Dr. John A. Allocca, WB2LUA

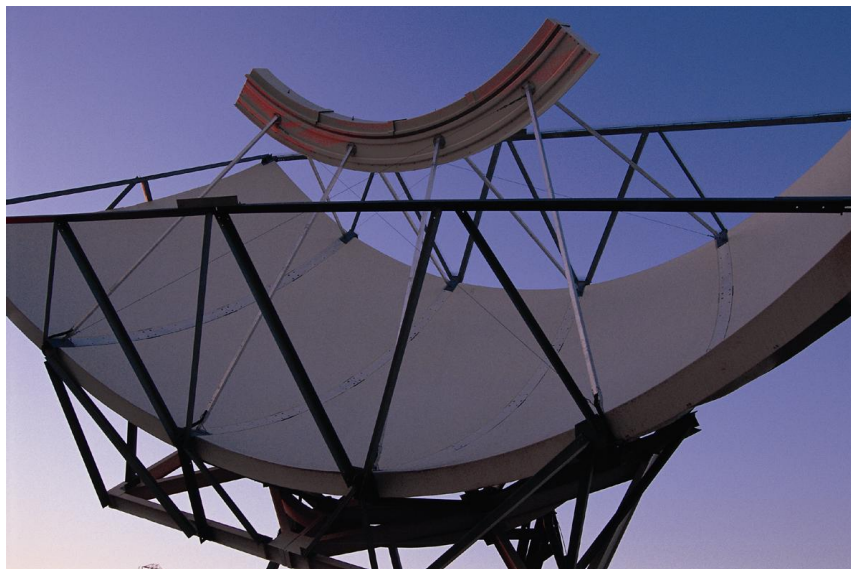

# Amateur Radio Emergency Communications Training Course

Dr. John A. Allocca, WB2LUA  
19 Lorraine Court, Northport, NY 11768  
(631) 757-3919  
john@allocca.com

Copyright 2004 – updated 10/13/09

This training course may be reproduced, provided it is reproduced in it's entirety without any changes

## TABLE OF CONTENTS

### Part 1 – Procedures

Amateur Radio Emergency Communications in the Community-----	6
Amateur Radio Emergency Service (ARES)-----	7
Radio Amateur Civil Emergency Service (RACES)-----	9
Principles of Disaster Communication-----	10
Working with Public Safety Officials and Agencies-----	12
National Traffic System (NTS)-----	13
Incident Command System (ICS)-----	14
Message Handling -----	16
Hurricane Intensity Scale-----	17
Estimating the Manpower Necessary to Cover an Emergency Event -----	18
The Emergency-----	19
Radiogram-----	20
ITU Phonetic Alphabet -----	21
International Q Signals-----	22
Emergency Response Checklist-----	24
Volunteer Handout -----	26
Town ARES/RACES Net Dialog-----	29

County ARES/RACES Net Dialog-----	30
Local Frequencies-----	33
Protective Equipment and Precautions-----	34
Guidance for Emergency Communications (FEMA)-----	39
New York State RACES Standard Operating Procedure-----	52
Final Exam-----	56

## **Part 2 – Technical**

Packet Radio-----	63
PSK Radio-----	82
Winlink 2000-----	86
Satellite Radio-----	93
Antennas and Propagation-----	101
H.F. Antenna Analysis-----	110
Mast and Antennas for Field Day and Emergencies-----	116
Cross Band and Fixed Band Repeaters-----	122
Emergency Power-----	123
US Amateur Bands-----	129
Amateur Radio Call Sign Numerical Prefixes-----	131
Anderson Powerpoles-----	133
ITU Phonetic Alphabet-----	134
International Q Signals-----	135
Signal Reporting-----	137
CTCSS (PL) Tone Frequencies-----	138
Mobile Emergency Communications Center-----	139

Emergency Communications Backpack Radio-----	143
Quick-Install-Uninstall Mobile Radio-----	146
Solar Power for Emergency Communications -----	149
Lightweight Portable Emergency Communications System -----	158

### **Part 3 – Emergency Preparedness**

Emergency Preparedness (Excerpts from FEMA Independent Study Course IS-2 “Emergency Preparedness U.S.A.”) -----	164
A Citizen’s Guide to Disaster Assistance (Excerpts from FEMA Independent Study Course IS-7/October 1999) -----	219

# Part 1

# Procedures

# Amateur Radio Emergency Communications in the Community

Every major disaster throughout the entire world represents sudden local emergency conditions where loss of life, limb, property, necessary resources and even the ability to call for help have been forced upon people somewhere. When the news story breaks and we hear about it in the midst of our daily lives, the story is about the event itself and the extensive upset to life at the scene. However, somewhere in those initial reports, you usually hear that it was some local ham radio operator who was first able to re-establish communications and get out the call for help. They're usually first, they're usually there, and they usually get it done!

In our country, these reliable, highly trained, and dedicated amateur radio or "ham" radio operators are the same people you know as friends and neighbors. Amateurs they are, as they receive no pay or compensation for the services they eagerly provide in such times of crisis. The pure satisfaction of provisioning extremely effective civil emergency communications is their fulfilling reward. You'll recall that it was ham radio operators who provided the first communications downtown on 9/11 when the WTC disaster eliminated electric power, radio, television, and even NYC emergency communications were disrupted. Hams established communications within a few hours, while it was days before anything else approached normal. And that was right here at home!

Amateur Radio ("ham") Operators must be trained and skilled in many aspects of communications and radio technology in order to pass strict federal licensing examinations to earn their Federal Communications Commission issued licenses and radio "call sign." In very real terms, they are anything but amateur in the performance and utilization of their skills. They own and maintain their own radio equipment and are responsible for all aspects of the operation of their radio stations, whether it is from a fixed base location, a mobile station, portable station, or from aircraft or marine locations. Hams have built, orbited, and operated their own satellites since 1961, only 4 years after the world's first satellite, Sputnik, blazed the skies. Hams are for real, and they are an incredibly valuable asset to the world, all the time!

Why use Amateur Radio? The answer is simple and obvious, and it's because amateur radio equipment is independent of commercial radio services like telephones, cell phones, and even Police, Fire, and EMS service radio services, which are very limited in frequency and interoperability. Ham radio (Amateur Radio) is inherently frequency agile and readily portable, thus it is ideal for emergency dependability. Many hams are able to pick up and go, and set up communications on a moment's notice from almost anywhere. Many do just that for the enjoyment of it. You'll see hams in the parks and around towns providing supporting communications for public events like parades, marathon runs, etc. Such events are easy practice for hams, yet major events like the Boston Marathon and the New York Marathon critically depend on them because hams get the job done.

# Amateur Radio Emergency Service (ARES)

The Amateur Radio Emergency Service (ARES) is a private volunteer organization of licensed amateur radio operators. It is not a part of any government organization. The only qualifications required are a valid FCC amateur radio license. ARES may assist private organizations, such as The American Red Cross, The Salvation Army, etc. ARES may also assist with community events such as marathon races. Only certified RACES personnel can assist government organizations, such as state, county, town, village, police, fire, EMS, etc. ARES is organized as follows:

## National

- Advising all ARES officials.
- Setting and carrying out the League's policies.

## Section

- Section Manager appoints the Section Emergency Coordinator (SEC).
- Section Emergency Coordinator (SEC).
- The Section manager is elected by the ARRL members in the section.
- The Section manager delegates to the SEC the section emergency plan.
- The Emergency Coordinator has the authority to appoint District and local EC's.

## Local

- The local Emergency Coordinator (EC) is the key contact.
- Direct contact with the ARES volunteers and with officials of the agencies to be served.
- The EC is appointed by the SEC, usually on the recommendation of the DEC.

## District

- In large sections, SECs have the option of grouping their EC jurisdictions into "districts"
- SEC appoints a District EC to coordinate the activities of the local ECs in the district.

## Assistant EC's

- Assistant Emergency Coordinators (AEC) head up special interest groups or projects.
- AEC's are designated by the EC to supervise activities of groups or projects.
- AEC's provide relief for the EC.

## **ARES Operation During Emergencies and Disasters**

- Operation in an emergency net requires preparation and training.
- Handling of written messages (traffic handling).

## **The ARRL Simulated Emergency Test (SET)**

- Nationwide exercise in emergency communications, administered by ARRL Emergency
- Coordinators and Net Managers.
- ARES and the National Traffic System (NTS) are involved.
- SET provides the opportunity to discover the emergency communications capabilities.
- SET weekend is held in October, and is announced in QST.
- To find out the strengths and weaknesses of ARES and NTS.
- To provide a public demonstration to served agencies such as Red Cross and through the news media to the public.
- To help radio amateurs gain experience in emergency communications.

## **During the SET**

- The "emergency" situation is announced and the emergency net is activated.
- Stations are dispatched to their positions.
- Designated stations originate messages to test the system.
- Test messages may be sent simulating requests for supplies.
- Tactical communications for served agencies is emphasized.

## **After the SET**

- Critique session to discuss the test results and review good points and weaknesses.

## **ARES Mutual Assistance Team (ARESMAAT)**

- ARES members in an affected area may not be able to respond to ARES operation because of their own personal situations.
- Communications support must come from ARES volunteers outside the affected areas.



# Radio Amateur Civil Emergency Service (RACES)

RACES is authorized by local, county, state, and federal emergency management agencies, under the direct control of the Federal Emergency Management Agency (FEMA) of the United States government. Amateur Radio Service provides radio communications during periods of local, regional or national civil emergencies.

As defined in the FCC rules, RACES is a radio communication service, conducted by volunteer licensed amateurs, designed to provide emergency communications to local or state civil-preparedness agencies. RACES operation is authorized by emergency management officials only.

To become a member of RACES, a licensed amateur radio operator must be officially enrolled in the local civil-preparedness agency having jurisdiction. Operator privileges in RACES depend upon the class of license held. In the event that the President invokes his War Emergency Powers, amateurs involved with RACES might be limited to certain specific frequencies (while all other amateur operation could be silenced). Originally, RACES was designed for wartime. It has evolved over the years to include all types of emergencies to government organizations, such as town, county, state, police, fire, EMS, etc. Only certified RACES personnel may assist government organizations and workers through the incident command system.

## Dedicated RACES Operating Frequencies

1800-1825 kHz  
1975-2000 kHz  
3.50-3.55 MHz  
3.93-3.98 MHz  
3.984-4.000 MHz  
7.079-7.125 MHz  
7.245-7.255 MHz  
10.10-10.15 MHz  
14.047-14.053 MHz  
14.22-14.23 MHz  
14.331-14.350 MHz  
21.047-21.053 MHz  
21.228-21.267 MHz  
28.55-28.75 MHz  
29.237-29.273 MHz  
29.45-29.65 MHz  
50.35-50.75 MHz  
52-54 MHz  
144.50-145.71 MHz  
146-148 MHz  
222-225 MHz  
420-450 MHz  
1240-1300 MHz  
2390-2450 MHz

# Principles of Disaster Communication

## Principles of Disaster Communications

- Keep the non-critical communications level down.
- If you're not sure you should transmit, don't.
- Study the situation by listening.
- Don't transmit unless you are sure you can help by doing so.
- Don't ever break into a disaster net just to inform the control station you are there if needed.
- Monitor established disaster frequencies.
- On CW, SOS is universally recognized.
- On voice, "MAYDAY" or "EMERGENCY" is universally recognized.
- Avoid spreading rumors.
- Authenticate all messages.
- Strive for efficiency.
- Select the mode and band to suit the need.

## CW Mode

- Less non-critical communications in most amateur bands.
- Some secrecy of communications - less likely to be intercepted by the general public.
- Simpler transmitting equipment.
- Greater accuracy in record communications.
- Longer range for a given amount of power.

## Voice Mode

- More practical for portable and mobile work.
- More widespread availability of operators.
- Faster communication for tactical or "command" purposes.
- Official-to-official and phone-patch capability.

## Digital Modes

- Less non-critical communications in most amateur bands.
- Secrecy of communications - less likely to be intercepted by the general public with a scanner.
- Greater speed.
- Potential for message store-and-forward capability from within the disaster site to the "outside world."
- Provides the capability of "digipeating" messages from point A to point Z via numerous automatically-controlled middle points.

# Working with Public Safety Officials and Agencies

Volunteers must be accepted by public-officials. Once accepted, they can contribute in times of disaster. Acceptance is based on establishing a track record of competent performance in important activities. This may include parades, runs, and various other local events.

Police and fire officials tend to be very cautious and skeptical concerning those who are not members of the public-safety professions. This posture is based primarily on experiences where volunteers have complicated, and jeopardized, efforts in emergencies.

Volunteers need to demonstrate the reliability and clarity of amateur gear. Police and fire officials are very impressed to witness a roll call on a 2-meter repeater using a hand-held radio in the police or fire chief's office and having amateurs respond with full-quieting signals from locations where municipal radios are often ineffective.

As funding becomes less available, agencies are looking for volunteers. Relationships with served agencies are vitally important and valuable to radio amateurs. We provide them with communications. They provide us with the opportunity to contribute to the relief of suffering.

A detailed local operational plan should be developed with local agency managers. The plan should include the technical issues involving message format, security of message transmission, disaster welfare inquiry policies, etc.

# National Traffic System (NTS)

The National Traffic System is a plan for handling amateur radio traffic. It is designed for rapid movement of traffic from origin to destination. It is also designed to train amateur operators to handle written traffic and participate in directed nets. The NTS consists of operators who participate for one or two periods a week, and some who are active daily.

Each net performs its function and only its function in the overall organization. To be an individual station in NTS, one must be issued certificates, and be appointed to the field organization's traffic handling position, entitled Official Relay Station.

Voice, CW, RTTY, AMTOR, packet or other digital mode is set up by the Net Manager or Managers concerned and the dictates of logic. There is only one National Traffic System, not separate systems for each mode.

Local nets are cover small areas such as a community, city, county or metropolitan area. They usually operate by 2-meter FM and use repeaters. A local net, or "node," may also be conducted on a local packet BBS.

## Region nets cover a wider area, such as a call area. Regional nets consist of:

- A net control station, designated by the region net manager.
- Representatives from each of the various sections in the region, designated by their section net managers.
- One or more stations designated by the region net manager to handle traffic going to points outside the region.
- One or more stations bringing traffic down from higher NTS echelons.
- Any other station with traffic.

## Area Nets are at the top level of NTS nets. Area nets consist of:

- A net control station, designated by the area net manager.
- One or more representatives from each region net in the area, designated by the region net managers.
- Stations designated to handle traffic going to other areas.
- Stations designated to bring traffic from other areas.
- Any station with traffic.

Digital Stations handle traffic among sections, regions and areas. These stations handle traffic by digital modes. They supplement the existing system, providing options, and flexibility in getting traffic moved expeditiously across the country, especially in overload conditions.

# Incident Command System (ICS)

Almost all emergency government agencies have adopted the incident command system. It is a management tool that provides a coordinated system of command structure. Amateur radio operators should familiarized themselves with the system and how they may interface with government agencies that use the ICS.

The basic concept of the ICS is having a unified command. There is one person in charge of the emergency, the incident commander, who is totally responsible for everything that occurs in that emergency operation.

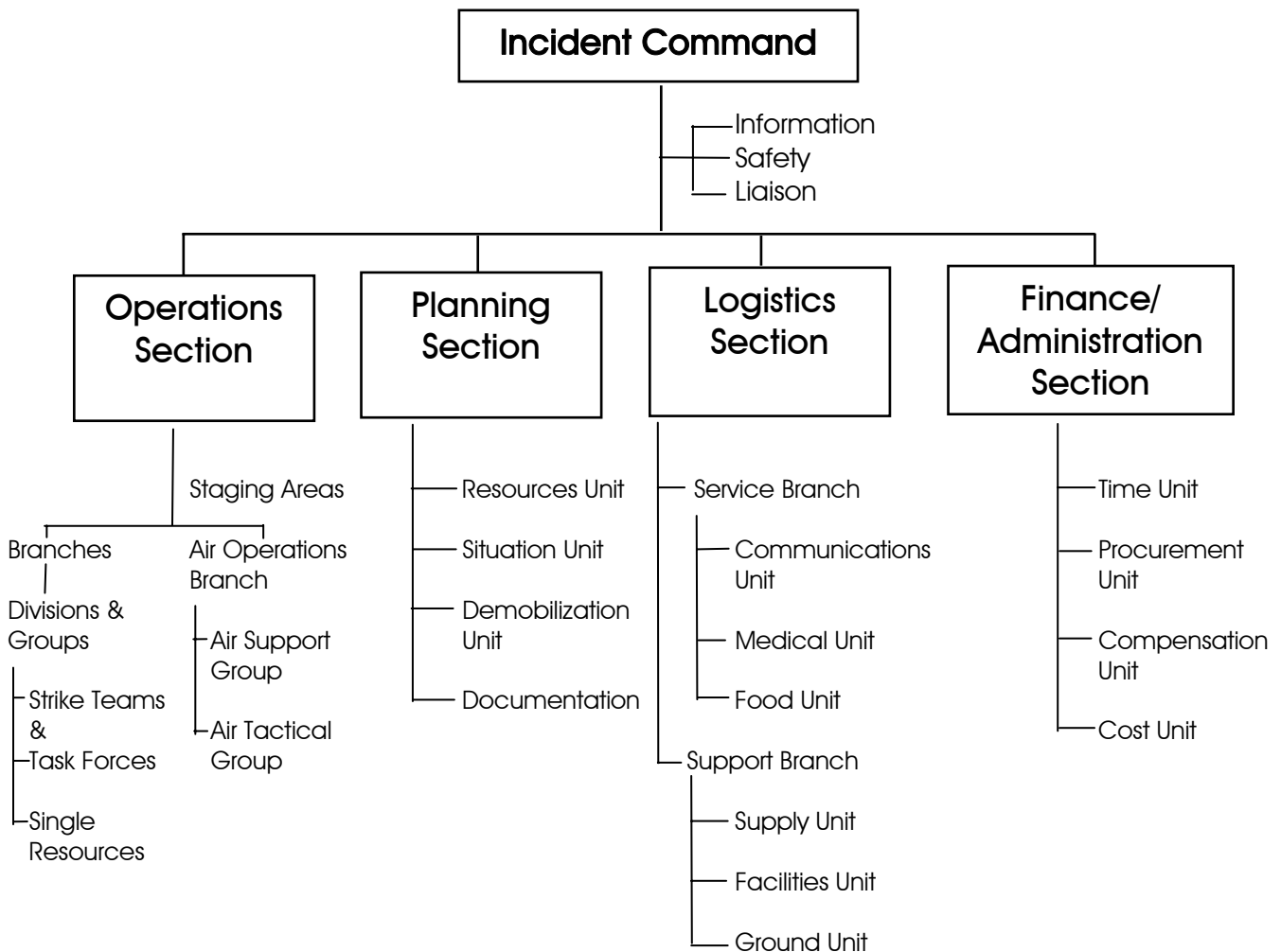

**Command** – Set objectives and priorities. Has overall responsibility at the incident or event.

**Operations** – Conducts tactical operations to carry out the plan. Develops the tactical objectives, organization, and directs all resources.

**Planning** – Develops the action plan to accomplish the objectives. Collects and evaluates information. Maintains the resource status.

**Logistics** – Provides support to meet incident needs. Provides resources and all other services needed to support the service.

**Finance / Administration** – Monitors costs related to incident. Provides accounting, procurement, time recording and cost analysis.

**Incident Facilities:**

1. Incident Command Post (ICP) – The location from which the Incident Commander oversees all incident operations

2. Staging Areas – Locations at which the resources are kept while awaiting incident assignment. Large incidents may have several staging areas.

3. Base – The location at the incident at which primary service and support activities are performed.

4. Camps – Incident locations where resources may be kept to support incident operations. These resources may not be immediately available.

5. Helibase – A location in and around an incident area at which helicopters may be parked, maintained, fueled, and equipped for incident operations.

6. Helispots – Helispots are temporary locations where helicopters can land and load and off-load personnel, equipment, and supplies. Large incidents may have several helispots.

# Message Handling

1. Speak in plain language.
2. Speak slowly and clearly.
3. Remain calm at all times.
4. If you have an emergency message, state the word “emergency” followed by your call sign.
5. If you have a priority message, state the word “priority” followed by your call sign.

**Emergency** – any message having life and death urgency to any person or group of persons.

**Priority** – any important message that has a specific time limit.

**Welfare** – can be either an inquiry as to the health and welfare of an individual in the disaster area, or an advisory from the disaster area that indicates all is well.

**Routine** – Most traffic will be routine in nature. In a disaster situation, routine messages should be handled last.



# Hurricane Intensity Scale

Saffir-Simpson Hurricane Scale.

<u>Category</u>	<u>Wind Speed</u>	<u>Barometric Pressure</u>	<u>Storm Surge</u>	<u>Damage Potential</u>
1 (weak)	75 - 95 mph	28.94" +	4' - 5'	Minimal damage to vegetation
2 (moderate)	96 - 110 mph	28.50" - 28.93"	6' - 8'	Moderate damage to houses
3 (strong)	111 - 130 mph	27.91" - 28.49"	9' - 12'	Extensive damage to small buildings
4 (very strong)	131 - 155 mph	27.17" - 27.90"	13' - 18'	Extreme structural damage
5 (devastating)	155 mph +	less than 27.17"	18' +	Catastrophic building failures possible

The National Hurricane Center monitors 14.325 MHz and takes reports from Amateur Radio Operators during the storm. Hurricane season is June 1 to November 30.

NOAA Weather Radio:

162.400 mhz  
162.425 mhz  
162.450 mhz  
162.475 mhz  
162.500 mhz  
162.525 mhz  
162.550 mhz

# Estimating the Manpower Necessary to Service an Emergency Event

## One Person Per Shift

**Assuming the following:**

12 hour shifts

1 people per shift

A volunteer may only volunteer one out of every three days.

**Therefore:**

2 people are needed to cover 1 day

4 people are needed to cover 2 days

6 people are needed to cover 3 days

**Conclusion:**

6 people are needed to cover one assignment location.

12 people are needed to cover two assignment locations, and so on.

## Two People Per Shift

**Assuming the following:**

12 hour shifts

2 people per shift

A volunteer may only volunteer one out of every three days.

**Therefore:**

4 people are needed to cover 1 day

8 people are needed to cover 2 days

12 people are needed to cover 3 days

**Conclusion:**

12 people are needed to cover one assignment location.

24 people are needed to cover two assignment locations, and so on.

# The Emergency

Sometimes volunteers are called upon because emergency communications is needed immediately. Other times, volunteers are called upon to serve as back-up support in anticipation of losing total communications. Don't be discouraged if your services don't appear to have been useful. Having you there in place and ready to operate provides a very valuable service.

## First Step

Before volunteering for emergency communications, be sure of the following:

- Family are safe and secure.
- Family has enough provisions, etc.
- Property is safe
- Monitor the designated frequencies, radio, and t.v.
- Contact your Emergency Coordinator or designee for instructions.
- Check batteries.
- Check medications if applicable.

## Second Step

- Know and understand the volunteer handout.
- Do not take action until you are told to act.
- Be prepared to operate.
- Check all equipment and connections.
- Have pencil, paper, and radiograms ready.
- Obtain tactical frequencies.
- Check-in with your designated net or operations.
- Obtain tactical call sign if appropriate.
- Monitor all frequencies assigned to you.
- Notify net control operator if you have to leave.

## Field Operations

- **BE SURE TO ABSOLUTELY FOLLOW THE CHAIN OF COMMAND!**
- If you are operating in the field, always keep a safe distance from any hazards.
- Keep yourself well hydrated (drink plenty of water).
- Take breaks and get rest when you can.
- Do not overexert yourself. Be aware of your own limitations.
- Do not overreact, become hysterical, or try to provide more help than is needed.
- **DO NOT BECOME A VICTIM YOURSELF**

# Radiogram

Number \_\_\_\_\_

Precedence \_\_\_\_\_

Station of Origin \_\_\_\_\_

Place of Origin \_\_\_\_\_

Date Filed \_\_\_\_\_

Time Filed \_\_\_\_\_

To \_\_\_\_\_

\_\_\_\_\_

Telephone Number (         ) \_\_\_\_\_

Received at:

Station \_\_\_\_\_

Name \_\_\_\_\_

Street Address \_\_\_\_\_

City, State, Zip \_\_\_\_\_

Text \_\_\_\_\_

\_\_\_\_\_

\_\_\_\_\_

\_\_\_\_\_

\_\_\_\_\_

\_\_\_\_\_

\_\_\_\_\_

\_\_\_\_\_

\_\_\_\_\_

\_\_\_\_\_

\_\_\_\_\_

Received From \_\_\_\_\_

Date \_\_\_\_\_

Time \_\_\_\_\_

Sent to \_\_\_\_\_

Date \_\_\_\_\_

Time \_\_\_\_\_

# ITU Phonetic Alphabet

A - Alpha

B - Bravo

C - Charlie

D - Delta

E - Echo

F - Foxtrot

G - Golf

H - Hotel

I - India

J - Juliet

K - Kilo (pronounced keelo)

L - Lima (pronounced leema)

M - Mike

N - November

O - Oscar

P - Papa

Q - Quebec (pronounced kaybek)

R - Romeo

S - Sierra

T - Tango

U - Uniform

V - Victor

W - Whiskey

X - X-ray

Y - Yankee

Z - Zulu

# International Q Signals

QRA - What is your call sign?

QRG - Will you tell me my exact frequency (or the frequency of...)?

QRH - Does my frequency vary?

QRI - What is the tonal quality of my transmission?

QRJ - Are you receiving my transmissions poorly?

QRK - What is the intelligibility of my signals?

QRL - Are you/is the frequency busy? More!

QRM - Is there man-made interference to my transmissions? More!

QRN - Are you troubled by static or some other natural source of noise? (ok, cut the jokes ;-) More!

QRO - Shall I increase power? More!

QRP - Shall I decrease power? More!

QRQ - Shall I send faster? More!

QRS - Shall I send more slowly?

QRT - Shall I stop sending? More!

QRU - Do you have anything for me?

QRV - Are you ready? More!

QRX - When will you call me again?

QRY - What is my turn?

QRZ - Who is calling me?

QSA - What is the strength of my signals?

QSB - Are my signals getting weaker? More!

QSD - Is my keying defective?

QSG - Shall I send (number) messages at a time?

QSK - Can you hear me in between your signals and may I break in? More!

QSL - Can you acknowledge receipt? More!

QSLL - I will QSL on receipt of your QSL card. More!

QSM - Shall I repeat the last message I sent to you?

QSN - Did you hear my transmissions on (frequency)?

QSO - Can you communicate with me? More!

QSP - Will you relay to (station)?

QST - General call preceding a message addressed to all Amateurs. More!

QSU - Shall I send or reply on this frequency?

QSW - Will you send on this frequency?

QSX - Will you listen on (frequency)?

QSY - Shall I change transmission to another frequency?

QSZ - Shall I send each word or group more than once?

QTA - Shall I cancel message (number)?

QTB - Do you agree with my word count?

QTC - How many messages do you have to send?

QTH - What is your location?

QTR - What is the correct time?

# Emergency Response Checklist

Note: The necessity for the following items will vary from event to event. Check with your immediate supervisor before bringing any of the following.

## COMMUNICATIONS (Base Station)

- Dual band, 144/440 mhz, 50 watt, transceiver
- Switching power supply
- Magnet mount antenna
- Baking tray (use as ground plane)
- Microphone
- Battery clips
- Instruction manual
- TNC and Cables
- Notebook computer set up for packet

## COMMUNICATIONS (Portable)

- Dual band, 144/440 mhz, 5+ watt, handitalkie
- High gain antenna
- Microphone
- Headset if available
- Cigarette lighter adapter
- Battery Charger
- AA battery adapter
- AA batteries
- Waste pack to hold handitalkie and water
- Instruction manual

## COMMUNICATIONS (Listening)

- Scanner
- AC Adapter
- Extra batteries
- Instruction manual

## COMMUNICATIONS (Telephone)

- Cell phone
- Cell phone ac charger
- Cell phone cigarette lighter charger

## CABLES AND ACCESSORIES

- 2 RG58 cables (10' or more)
- 2 110v extension corders (10' or more)
- Outlet strip
- 3 prong to 2 prong ac adapter
- Soldering equipment and some basic tools
- Wire
- Electrical tape
- Extra UHF connectors (wireless)
- Female to female UHF connector
- Alligator clip leads
- First aid kit
- Bungee cords
- 1/8" nylon twine (25')
- Flashlight with extra bulb
- Extra flashlight batteries
- Pen
- Pencil
- Paper
- Playing cards or game
- Reading material
- Hand tools

## PERSONAL PROTECTION

- Organic vapor breathing mask
- Hard hat
- Surgical gloves
- Goggles/eye protection
- Tyvek suit
- Hiking boots

## PERSONAL IDENTIFICATION

- Personal name badge
- Luggage tags on all luggage and cases.
- FCC license
- Drivers license
- ARES/RACES cards
- ID Lanyard



**CLOTHING AND MISCELLANEOUS**

- One complete change of clothing
- One week of underwear
- One week of socks
- One week of vitamins
- One week or more of personal medications
- Pajamas
- Hat
- Rain suit or waterproof clothing
- Gloves
- Handkerchief
- Extra shoe laces
- Toilet paper
- Tissues
- Water bottle
- Umbrella
- Insect repellent
- Wash 'n dri

**TOILETRIES**

- Shampoo
- Conditioner
- Soap
- Comb
- Brush
- Razor
- Shaving cream
- Cologne
- Deodorant
- Powder
- Toothbrush
- Toothbrush holder
- Toothpaste
- Scissor
- Tweezers
- Nail clipper
- Nail file
- Cotton
- Q-Tips
- Hair dryer
- Dental floss
- Sunscreen
- Chap stick
- Tooth picks

**FIRST AID KIT**

- Rubbing Alcohol
- Hydrogen peroxide
- Cotton
- Band-Aids
- First Aid Cream
- 4" gauze pads
- 1" adhesive tape
- 2" gauze bandage
- 4" ace bandage
- Triangular bandage
- Advil
- Tylenol
- Tweezers
- Scissor
- Snake bite kit
- Hydrocortisone cream
- Eyewash
- Rubber gloves
- CPR mask
- Flashlight

# Volunteer Handout

Thank you for volunteering your time for this disaster Incident. Your help is greatly appreciated by one and all. Sometimes volunteers are called upon because emergency communications is needed immediately. Other times, volunteers are called upon to serve as back-up support in anticipation of losing total communications. Don't be discouraged if your services don't appear to have been useful. Having you there in place and ready to operate provides a very valuable service.

Call Sign \_\_\_\_\_ Name \_\_\_\_\_

Assignment \_\_\_\_\_

Contact Person \_\_\_\_\_

Report to location \_\_\_\_\_

DEC Officer \_\_\_\_\_

EC/RO Officer \_\_\_\_\_

AEC/DRO Officer \_\_\_\_\_

Agency official in charge \_\_\_\_\_

Tactical Name \_\_\_\_\_ Frequency \_\_\_\_\_

Tactical Name \_\_\_\_\_ Frequency \_\_\_\_\_

Tactical Name \_\_\_\_\_ Frequency \_\_\_\_\_

Tactical Name \_\_\_\_\_ Frequency \_\_\_\_\_

Tactical Name \_\_\_\_\_ Frequency \_\_\_\_\_

Tactical Name \_\_\_\_\_ Frequency \_\_\_\_\_

Tactical Name \_\_\_\_\_ Frequency \_\_\_\_\_

Tactical Name \_\_\_\_\_ Frequency \_\_\_\_\_

Tactical Name \_\_\_\_\_ Frequency \_\_\_\_\_

Tactical Name \_\_\_\_\_ Frequency \_\_\_\_\_

Tactical Name \_\_\_\_\_ Frequency \_\_\_\_\_

Tactical Name \_\_\_\_\_ Frequency \_\_\_\_\_

Tactical Name \_\_\_\_\_ Frequency \_\_\_\_\_

Notes: \_\_\_\_\_

Notes: \_\_\_\_\_

Notes: \_\_\_\_\_

Notes: \_\_\_\_\_

Notes: \_\_\_\_\_

### **Do's:**

- All communications are to be brief and concise as possible.
- Ask questions if you're not sure.
- Be accurate.
- Follow instructions.
- Take breaks when needed.
- Inform net if you will be unavailable.

### **Don'ts:**

- Try to do more than you can.
- Change your instructions.

## **The Incident Command System (ICS)**

The Incident Command System (ICS) is a management tool used to assist anyone who has the responsibility for the successful outcome of an incident. It is defined as any planned or unplanned occurrence or event, regardless of cause, which requires action by emergency service personnel to prevent or minimized loss of life or damage to property. The ICS is structured in two parts.

### **Part I – Management by Objectives**

1. Understanding policy, procedures, and statues.
2. Establish incident objectives
3. Select appropriate strategy
4. Apply tactics most likely to accomplish objectives by assigning correct resources and monitor results.

### **Part II – Organization Structure**

1. The ICS structure begins with the Incident Commander (IC). The IC is responsible for the management of the incident and begins by setting incident objectives.
2. Often an incident may cross boundaries. Unified Command is the ICS process that allow the multiple jurisdiction to develop unified objectives and strategies for the incident.

Radiogram attached

# Town ARES/RACES Net Dialog

(Day) \_\_\_\_\_ (Time) \_\_\_\_\_ hours

(Frequency) \_\_\_\_\_ mhz, (Offset) \_\_\_\_\_ hz, (Tone PL) \_\_\_\_\_

## OPENING THE ARES/RACES NET

CQ, CQ, CQ, all amateur radio operators. Does anyone need the repeater for emergency or priority traffic? *(drop)*

Attention all stations. This is the (Town) \_\_\_\_\_ District (Number) \_\_\_\_\_  
Amateur Radio Emergency Service and Radio Amateur Civil Emergency Service net, also known  
as the ARES/RACES net, conducted on the (Club Name) \_\_\_\_\_  
(Repeater Call Sign) \_\_\_\_\_ repeater in (Town) \_\_\_\_\_  
(State) \_\_\_\_\_ *(drop)*.

During times of declared disaster or emergency, or during official training and exercise sessions,  
RACES communications are conducted on behalf of local government and are considered as official  
governmental communications. This weekly net is a directed net and is conducted for the purpose of  
RACES training, operating procedures, and routine administration. Your net control for tonight  
(Date) \_\_\_\_\_ is (Your Call Sign) \_\_\_\_\_,  
(Phonetic Call Sign) \_\_\_\_\_ *(drop)*.

A directed net is created when there are a number of stations needing to use the Frequency or  
the volume of traffic cannot be dealt with on a first-come first-served basis. The Net Control Station will  
determine who uses the frequency and what traffic will be passed first *(drop)*.

Please do not break into the net without direction from net control. If you do have an  
emergency during the net please state the word "emergency" followed by your call and the frequency  
will be turned over to you for the duration of the emergency. If you have information for the net please  
use the word "info" followed by your call. If you have a question for the net please use the word "query"  
followed by your call *(drop)*.

When checking into this net, please use the hesitation method. The procedure is as follows: say  
"THIS IS ...". Release your push to talk switch to see if you are doubling with anyone. If you do not hear  
anyone else talking then proceed to give your call-sign phonetically, using the standard ITU phonetic  
alphabet and your name and state if you have any information dealing with emergency  
communications for the net by saying "I have traffic", then stand by and wait for net control to  
acknowledge you before doing anything else within the net *(drop)*.

Please do not leave this net unless you first inform net control and receive permission to do so. I  
will now stand by for anyone with emergency or priority traffic only *(drop)*.  
(IF NO TRAFFIC THEN PROCEED.)

If the group is large, then:  
The check-in procedure for this net is in two phases. First is a roll call of The ARES/RACES members. When  
you hear your call sign, respond with your call sign, your name, and state if you have traffic for the net.

The second phase will allow for all others to check-in. Net control will call each member that has traffic, respond with your call-sign and traffic *(drop)*.

If the group is small, then:

Since this is a small group, I will ask for check-ins. State your call-sign, your name, and If you have traffic *(drop)*.

*(ACKNOWLEDGE ALL STATIONS THAT CHECK INTO NET. STOP THE NET AND ASK THE NET TO STAND BY WHEN YOU NEED TO, SO YOU CAN WRITE DOWN EVERYONE CHECKING-IN. WHEN NO FURTHER STATIONS CHECK INTO THE NET THEN PROCEED WITH THE NET.*

*REMEMBER TO ASK FOR NEW CHECK-INS OR IF ANYONE HAS ANYTHING FOR THE NET EVERY FEW MINUTES [APPROX. 5 - 10]).*

### **ARES/RACES NET OPERATION PROCEDURE**

*(LIST ANY BULLETINS OR PRIORITY MESSAGES YOU MIGHT HAVE FOR THE NET.*

*LIST ANY CURRENT AND ADDITIONAL ARES/RACES INFORMATION FOR THE NET YOU MIGHT HAVE. HAVE EACH INDIVIDUAL STATION THAT STATED THEY HAVE INFO FOR THE NET*

*LIST WHAT THEY HAVE AND PASS IT. HANDLE ANY EDUCATIONAL INFORMATION TO BE COVERED DURING THIS NET.*

*REMEMBER TO HAVE A PAUSE TO SEE ANYONE THAT COMES INTO THE NET LATE WISHES TO CHECK-IN).*

### **ANNOUNCEMENTS**

### **CLOSING THE ARES/RACES NET**

Are there any final stations wishing to check into the net? *(drop)*

Are there any comments or questions? *(drop)*

*(IF THERE IS NO FURTHER ACTIVITY PROCEED TO CLOSE THE NET).*

This is *(Your Call Sign)* \_\_\_\_\_, net control station for this session of the *(Town)* \_\_\_\_\_ ARES/RACES Net thanking all of the stations that checked-in today for participating and supporting the net. I also want to thank those stations that did not check in for standing down while the net was in operation. Your help in maintaining this net is greatly appreciated by one and all *(drop)*.

This net is repeated every *(Day)* \_\_\_\_\_ at *(Time)* \_\_\_\_\_ hours. All stations may now secure from this net. This is *(Your Call Sign)* \_\_\_\_\_ closing the net at *(Time)* \_\_\_\_\_ local time and returning the repeater to regular amateur radio operation. Good evening. *(drop)*.

\* Note: Blanks should be filled in during training sessions.

# County ARES/RACES NET Dialog

(Day) \_\_\_\_\_ (Time) \_\_\_\_\_ hours

(Frequency) \_\_\_\_\_ MHz, (Offset) \_\_\_\_\_ hz, (Tone PL \_\_\_\_\_)

## NET INTRODUCTION PROCEDURE

CQ, CQ, CQ, all amateur radio operators. Does anyone need the repeater for emergency or priority traffic? *(drop)*

Calling together the (County) \_\_\_\_\_ county ARES/RACES Net. This is *(Your Call Sign)* \_\_\_\_\_.  
(Phonetic Call Sign) \_\_\_\_\_,  
(Town) \_\_\_\_\_ ] (ARES/RACES Officer) \_\_\_\_\_,  
(RACES ID) \_\_\_\_\_ I will be your net control station for this session of the  
[County \_\_\_\_\_] county ARES/RACES Net for (Date) \_\_\_\_\_. This net  
meets on (Day's) \_\_\_\_\_ at (Time) \_\_\_\_\_ hours local time through the  
facilities of the (Club Name) \_\_\_\_\_ repeater  
(Repeater Call Sign) \_\_\_\_\_. *(drop)*

The purpose of this net is to relay information that is of interest to amateur radio operators who assist with emergency communications within and around (County) \_\_\_\_\_ County, and assist in the training of local amateur radio operators to handle emergency communications. We welcome and encourage all amateur operators to check into this net even if you are not a member of ARES or RACES. *(drop)*

Please remember that this is a directed net. Please do not break into the net without direction from net control. If you do have an emergency during the net please state the word "emergency" followed by your call and the frequency will be turned over to you for the duration of the emergency. If you have information for the net please use the word "info" followed by your call. If you have a question for the net please use the word "query" followed by your call. *(drop)*

When checking into this net please use the hesitation method. The procedure is as follows: say "THIS IS ...". Release your push to talk switch to see if you are doubling with anyone. If you do not hear anyone else talking then proceed to give your call sign phonetically, using the standard ITU phonetic alphabet, your name, location, RACES ID number, and any position you hold within the emergency operations structure. Also state if you have any information dealing with emergency communications for the net, then stand by and wait for net control to acknowledge you before doing anything else within the net. *(drop)*

Please do not leave this net unless you first inform net control and receive permission to do so. I will now stand by for anyone with EMERGENCY or PRIORITY TRAFFIC ONLY. *(drop)*

I will now stand by for the regular net check-in by townships. Please remember to give your call slowly and phonetically along with your name, location, RACES number, and position for the benefit of everyone else in the net. Also please remember to state if you have anything for the net. *(drop)*

Order of check-ins:

Division 1 \_\_\_\_\_

Division 2 \_\_\_\_\_

Division 3 \_\_\_\_\_

Division 4 \_\_\_\_\_

Division 5 \_\_\_\_\_

Division 6 \_\_\_\_\_

Division 7 \_\_\_\_\_

Division 8 \_\_\_\_\_

Division 9 \_\_\_\_\_

Division 10 \_\_\_\_\_

Stations outside of (County) \_\_\_\_\_ county

*[ACKNOWLEDGE ALL STATIONS THAT CHECK INTO NET. STOP THE NET AND ASK THE NET TO STAND BY WHEN YOU NEED TO, SO YOU CAN WRITE DOWN EVERYONE CHECKING IN. WHEN NO FURTHER STATIONS CHECK INTO THE NET THEN PROCEED WITH THE NET*

*REMEMBER TO ASK FOR NEW CHECK-INS OR IF ANYONE HAS ANYTHING FOR THE NET EVERY FEW MINUTES [APPROX. 5 - 10]].*

### **NET OPERATION PROCEDURE**

*LIST ANY BULLETINS OR PRIORITY MESSAGES YOU MIGHT HAVE FOR THE NET. POLL EC'S OF EACH TOWNSHIP TO SEE IF THEY HAVE ANY INFORMATION FOR NET.*

*LIST ANY CURRENT AND ADDITIONAL ARES/RACES INFORMATION FOR THE NET YOU MIGHT HAVE. HAVE EACH INDIVIDUAL STATION THAT STATED THEY INFO FOR THE NET.*

*LIST WHAT THEY HAVE AND PASS IT.*

*HANDLE ANY EDUCATIONAL INFORMATION TO BE COVERED DURING THIS NET.*

*\*\* REMEMBER TO HAVE A PAUSE TO SEE ANYONE THAT COMES INTO THE NET LATE WISHES TO CHECK-IN.*

### **ANNOUNCEMENTS**

### **NET CONCLUSION PROCEDURE**

*[CALL FOR ANY FINAL STATIONS WISHING TO CHECK INTO THE NET AND CHECK TO SEE IF THERE ARE ANY FURTHER COMMENTS OR QUESTIONS. IF THERE IS NO FURTHER ACTIVITY PROCEED TO CLOSE THE NET.*

This is (Your Call Sign) \_\_\_\_\_ . (Town) \_\_\_\_\_ (ARES/RACES Officer) \_\_\_\_\_ and net control station for this session of the (County) \_\_\_\_\_ county ARES/RACES Net thanking all of the stations that checked in today for participating and supporting the net. I also want to thank those stations that did not check in

for standing down while the net was in operation. Your help in maintaining this net is greatly appreciated by one and all *(drop)*.

The *(County)* \_\_\_\_\_ county Amateur Radio Emergency Services wishes to again thank the *(Club Name)* \_\_\_\_\_ for the use of their repeater for the operation of this net. All stations may now secure. This net is now secured at *(Time)* \_\_\_\_\_ local time. This is *(Your Call Sign)* \_\_\_\_\_ returning the repeater to its normal amateur operation. Good Evening. *(drop)*

\* Note: Blanks should be filled in during training sessions.



# Local Frequencies

## Local Repeater Frequencies:

1. \_\_\_\_\_ MHz,      \_\_\_\_\_ Offset      \_\_\_\_\_ PL Tone
2. \_\_\_\_\_ MHz,      \_\_\_\_\_ Offset      \_\_\_\_\_ PL Tone
3. \_\_\_\_\_ MHz,      \_\_\_\_\_ Offset      \_\_\_\_\_ PL Tone
4. \_\_\_\_\_ MHz,      \_\_\_\_\_ Offset      \_\_\_\_\_ PL Tone
5. \_\_\_\_\_ MHz,      \_\_\_\_\_ Offset      \_\_\_\_\_ PL Tone
6. \_\_\_\_\_ MHz,      \_\_\_\_\_ Offset      \_\_\_\_\_ PL Tone
7. \_\_\_\_\_ MHz,      \_\_\_\_\_ Offset      \_\_\_\_\_ PL Tone
8. \_\_\_\_\_ MHz,      \_\_\_\_\_ Offset      \_\_\_\_\_ PL Tone
9. \_\_\_\_\_ MHz,      \_\_\_\_\_ Offset      \_\_\_\_\_ PL Tone
10. \_\_\_\_\_ MHz,      \_\_\_\_\_ Offset      \_\_\_\_\_ PL Tone

## Local Simplex Frequencies:

1. \_\_\_\_\_ MHz
2. \_\_\_\_\_ MHz
3. \_\_\_\_\_ MHz
4. \_\_\_\_\_ MHz
5. \_\_\_\_\_ MHz
6. \_\_\_\_\_ MHz
7. \_\_\_\_\_ MHz
8. \_\_\_\_\_ MHz
9. \_\_\_\_\_ MHz
10. \_\_\_\_\_ MHz

# Protective Equipment and Precautions

ARES/RACES personnel act in a communications function and not first care providers, so their risk should be minimal. This is a general guide to personal protective measures and equipment for prevention of injuries due to incidental exposure to physical / chemical / biological hazards at disaster sites where personnel may be deployed.

## General:

Officials shall not knowingly deploy or assign volunteers to any locations or assignments, which place them in physical danger. However, any field deployment poses a potential risk of accident or personal injury. Examples of common risk factors, which may be encountered by deployed personnel include:

- Travel hazards to and from the deployment site
- Weather or environmental effects, lightning, cold, wet, wind, dust, flying debris
- Incidental exposure to chemicals or pathogens in flood waters, etc.
- Terrain, slippery or insecure footing, risk of falls, injuries
- Tool or equipment use, risk of hand or eye injuries, electric shock
- Human factors, stress or fatigue.

## Responsibility:

Volunteers must be aware of potential hazards to which they could be exposed. Disaster Response Team members are required to provide their own sturdy footwear, work gloves, safety glasses and outdoor work clothing. Additional personnel protective equipment (PPE) such as hard hats and respirators is required for damage assessment work.

Leadership is responsible to conduct risk assessment with served agency officials. Mission planning should include precautions to mitigate ordinary hazards, identify potential incidental hazards and recommend appropriate personal protective measures. At minimum field team leaders must complete a Hazard Abatement Plan Checklist daily to perform a basic risk assessment for each deployment. Volunteers must be briefed daily before their deployment and be informed of specific hazards identified, an assessment of risk exposure, and planning precautions taken to ensure a safe working environment including provisions for job rotation, personal hygiene, housekeeping and maintenance to minimize exposures.

Served agencies are responsible under OSHA regulations, 29 CFR Part 1910 to employ all feasible engineering and work practice controls to eliminate, reduce or mitigate hazards. Volunteers serving state and local government agencies benefit from the same legal protection as paid staff to include safety orientation relevant to their assignments. The agency safety program shall systematically assess hazards, inform volunteer personnel why, when and what protective measures or equipment are necessary and to train volunteer staff in the application of said protective measures or equipment and to provide adequate safety equipment and require its use, whenever doing so is indicated by the OSHA Standard.

## Evaluating the Need for Personal Protective Equipment (PPE)

The following list is not all-inclusive, but provides some common examples of typical ARES/RACES operations where individuals may be exposed to hazards, which can be mitigated by proper selection, training and routine use of PPE.

### EYE PROTECTION:

Airborne dust and flying particles  
Hazardous chemical irritants  
Exposure to intense light or lasers  
Blood and/or body fluid splashes

### HEAD PROTECTION:

Falling and wind blown objects  
Low overhead clearances, exposed beams  
Confined spaces, foot travel in mountains  
Or heavily wooded terrain  
Exposed electrical wiring or components

### FOOT PROTECTION:

Penetrations by sharp, jagged objects  
Uneven, rocky, slippery, muddy ground  
Tools, equipment, rolling/falling objects  
Exposed electrical wiring or components  
Hazardous or flammable materials

### HAND PROTECTION:

Use of cutting tools  
Handling sharp or jagged materials  
Hazardous chemical irritants  
Blood and/or body fluid exposure  
Heat, abrasion exposure  
Exposed electrical wiring or components

### BODY PROTECTION:

Irritating dust or chemical splashes  
charging  
Exposure to sharp or jagged surfaces

### HEARING PROTECTION:

Noise from heavy equipment

### Potential Operations of Concern:

Damage assessment, Skywarn storm spotting  
Battery charging, soldering, equipment repairs  
Welding, cutting, laser operation  
First aid, emergency medical, triage, treatment

Tower and antenna work, Skywarn storm spotting  
Damage assessment  
Search and rescue operations

Power systems and communications, arc welding

Damage assessment  
Search & rescue operations  
Station set-up, logistics and supply  
Power systems and communications  
Fueling vehicles and generators

Power systems, communications, search & rescue,  
Damage assessment, logistics, material handling  
Battery charging, soldering, equipment repairs  
First aid, emergency medical, triage, treatment  
Soldering, field cooking, rope work, manual labor  
Power systems and communications

Debris clearance, battery maintenance and

Damage assessment, search and rescue operations

Machinery and generator noise.

## Criteria for Selection of Personal Protective Equipment (PPE)

### EYE PROTECTION:

- Protect against specific hazard(s) encountered
- Comfortable to wear
- Must not restrict vision or movement
- Durable and easy to clean and disinfect
- Must not interfere with function of other required PPE
- Meets requirements of ANZI Z87.1-1989, with side shields.

### FACE SHIELDS:

- Use in combination with goggles or safety glasses when you must protect yourself from impact hazards and chemical splashes (chain saws, power tools, risk of battery explosion)

### HEAD PROTECTION:

- Resists penetration by objects
- Absorbs shock of a blow
- Is water resistant and slow burning
- With instructions explaining proper adjustment, replacement of suspension and head band
- Meets requirements of ANZI Z89.1-1986, Class A or B.

### FOOT PROTECTION:

- Resists penetration by sharp objects
- Comfortable to wear
- Durable and easy to clean and disinfect
- Provide secure traction on slippery or irregular surfaces
- Provide ankle support
- Meets impact and compression protection requirements of ANZI Z41-1991
- May be designed to be electrically nonconductive to protect from electrical hazards

### HAND PROTECTION:

- Nature of hazard(s) and work to be performed determines proper selection of gloves
- Comfortable to wear
- Protect against heat and cold
- Cut, puncture and abrasion resistant
- Either durable and easy to clean or disinfect, or is single-use disposable
- Protect against chemical exposure and blood-borne pathogens
- Durable work gloves of leather or canvas (rope work, use of hand tools)
- Chemical and liquid resistant gloves (equipment, generator and battery maintenance)
- Medical exam gloves (First aid, emergency medical, triage, treatment)
- Detailed requirements for selection and use of insulating rubber gloves for use against electrical hazards.

### BODY PROTECTION:

- Environmental conditions, the nature of hazard(s) and work to be performed will determine proper selection of outer protective clothing
- Comfortable to wear
- Protect against heat, cold, wind, rain, chemical splashes
- Cut, puncture and abrasion resistant, durable and easy to clean.

All members are encouraged to provide their own N95 or R95 respirators for use in dusty environments such as damage assessment and debris clearance, even when exposures are below exposure limits, to provide an additional level of comfort and safety. R95 will provide some protection against nuisance gases.

## **Infection Control Awareness and Precautions**

### Types of Potentially Infectious Materials (“fomites”)

- **Body secretions / excretions**
  - Human: poor disaster sanitation conditions
  - Animal: livestock, rodents, vermin, insects
  - Decayed carcasses
- **Putrefiable materials**
  - Garbage and refuse
  - Spoiled foodstuffs
- **Allergens**
  - Concentrated fungi
  - Molds
- **Stagnant surface water**
  - Mosquito haborage
- **Contaminated flood waters**
  - Sewage, water treatment system overflow
  - Petroleum and agricultural chemical contamination
- **Structural instability**
  - Trauma risk, falls, sharps potential

### Mechanisms of Transmission

- **Direct contact** (“portal of entry”); non-intact skin
- **Penetrating injury** (percutaneous)
- **Aerosol**
- **Vector borne**
- **Physical injury**, causing portal of entry

### Categories of Transmissible Microorganisms

- **Tetanus** (occurrence likely in adults who have not received a dose of tetanus toxoid booster within 10 years, esp. agricultural workers contacting manure).
- **Hepatitis A, Hepatitis B** (C less likely)
- **Enteric bacteria** (e.g. E. coli, Salmonella)
- **Vermin-mediated**
  - Cats: Toxoplasmosis
  - Rats (urine): Leptospirosis
  - Tularemia
  - Plague (rat flea)
- **Toxins** (decaying, spoiled foodstuffs)
- **Vector-borne** (Lyme, West Nile, Malaria)

## Disaster Worker Protection

- Tetanus toxoid vaccine (booster recommended every 10 years)
- Hepatitis A/B vaccine
- Personnel protective equipment (PPE)
  - Awareness training
  - Correct sizes
  - Ample supply
- Medical screening (post-event) if symptoms

## **Guidelines for Follow-up of Exposure to Blood and Body Fluids**

In all exposure incidents the ARES/RACES member shall IMMEDIATELY notify the incident safety officer of the served agency. An exposure is not a simple contact. An exposure is a specific eye, mouth, other mucous membrane, non-intact skin or parenteral (piercing) contact with blood or potentially infectious material.

1. Clean the exposed area immediately with soap and water. If soap and water are not available, a disinfecting cleaner such as alcohol or antiseptic scrub should be used.

2. Notify your field team leader and the incident safety officer immediately after exposure occurs.

3. *The served agency safety officer will immediately contact the agency's consulting on-duty physician regarding the circumstances of the exposure. If needed, the physician will consult by phone with exposed personnel. Served agencies should have consulting physicians available 24 hours a day. The initial step will entail determining whether a true exposure has occurred. Appointments for testing, counseling or treatment will be made on the advice of the agency's consulting physician.*

4. If the consulting physician feels that an exposure has occurred, they will direct the employee to either come to their office immediately or go to the nearest facility to undergo blood sampling and consultation. CDC guidelines for post exposure prophylaxis (PEP) will be followed.

5. If the source patient is known, it is important to obtain information such as name, date of birth, social security number, address and phone number so that the physicians can contact them to arrange for testing.

6. If source patient is unknown, consulting physicians will follow CDC protocol for unknown source post exposure prophylaxis.

7. The served agency safety officer will ensure that the proper paperwork is completed such as Exposure Incident Report and Workers' Compensation forms.

8. If you have questions do not delay treatment. Go to the nearest hospital emergency room. Record all pertinent information regarding a specific exposure, using the following form and bring with you to the Emergency Room:

# Guidance for Radio Amateur Civil Emergency Service (FEMA)

Civil Preparedness Guide  
Federal Emergency Management Agency  
Washington, D.C. 20472  
CPG 1-15  
March 18, 1991

## Foreword

This Civil Preparedness Guide (CPG) has been prepared as a reference to assist State and local emergency management officials in establishing and operating Radio Amateur Civil Emergency Service (RACES) capabilities for use in responding to and managing emergencies and disasters. This CPG outlines the procedures for developing a RACES plan and provides an example of a plan format.

(Signed)

---

Grant C. Peterson  
Associate Director  
State and Local Programs And Support Directorate

Distribution: Special

## Contents

Foreword  
Contents

### Chapter 1 - General Information

- 1-1. Purpose
- 1-2. Applicability and Scope
- 1-3. Authority
- 1-4. Reference
- 1-5. Background
- 1-6. Definitions
- 1-7. State and Local Governments' Role
- 1-8. FEMA's Role
- 1-9. Emergency Situation

### Chapter 2 - Eligibility and Procedures for RACES

- 2-1. General
- 2-2. RACES Eligibility
- 2-3. Procedures for Establishing a RACES Organization
- 2-4. Recruitment and Retention

- 2-5. Training
- 2-6. Development of a RACES Plan
- 2-7. RACES Activation
- 2-8. RACES Unit Records

### Chapter 3 - Operations - War Time Emergency Situations and RACES Drills

- 3-1. General
- 3-2. List of Frequencies (Wartime Emergency Situations)
- 3-3. Message Format and Transmission Mode
- 3-4. General Limitations
- 3-5. Limitation on the Use of RACES Stations (Wartime Emergency Situations)

### Appendix - RACES Service Plan for the Support of Local Government During Emergencies

## Chapter 1 - General Information

- 1-1. Purpose
- 1-2. Applicability and Scope
- 1-3. Authority
- 1-4. Reference
- 1-5. Background
- 1-6. Definitions
- 1-7. State and Local Governments' Role
- 1-8. FEMA's Role
- 1-9. Emergency Situations

### 1-1. Purpose.

This Civil Preparedness Guide (CPG) provides guidance to State and local governments that utilize Radio Amateur Civil Emergency Service (RACES) as a means of emergency communications.

### 1-2. Applicability and Scope.

a. The provisions of this CPG are applicable to State and local Governments that Utilize RACES in emergencies.

b. In cases of conflict, Federal Communications Commission (FCC) Rules and Regulations will take precedence over the provisions of this CPG.

### 1-3. Authorities.

a. The Communications Act of 1934, Section 606, as amended.

b. Executive Order 12472, Assignment of National Security and Emergency Preparedness Telecommunications Functions.

### 1-4. Reference.

Title 47 Code of Federal Regulations (CFR), Part 97, Subpart F, and RACES.



### 1-5. Background.

a. RACES is an organization of amateur radio operators who volunteer to provide radio communications for State and local governments in times of emergency. Created in 1952 primarily to serve in civil defense emergencies, RACES provides essential communications and warning links to supplement State and local government assets during emergencies.

b. RACES is a special part of the amateur operation sponsored by the Federal Emergency Management Agency (FEMA). RACES provides emergency communications for civil preparedness purposes only. RACES is conducted by amateurs using their primary station licenses or by existing RACES stations. In the event that the President invokes the War Emergency powers, amateurs officially enrolled in the local civil preparedness group would become limited to certain frequencies, while all other amateur operations would be silenced.

### 1-6. Definitions.

a. **RACES** is a radio communications service, conducted by volunteer licensed amateur radio operators, for providing emergency communications support to State and local governments.

b. **RACES Station** is an amateur radio station licensed civil defense organization, at a specific land location, to provide the facilities for amateur radio communications in the RACES.

c. **Amateur Radio Communications** is noncommercial radio communications by or among amateur radio stations solely with a personal aim and without pecuniary or business interest.

### 1-7. The Role of State and Local Governments.

a. **Local Governments.** The role of local governments is to establish and train a RACES organization designed to provide or supplement essential emergency communications within their local jurisdiction.

b. **State Governments.** The role of State governments is to establish and train a RACES organization designed to provide or supplement emergency communications between elements of State Government and between State and local governments.

### 1-8. FEMA's Role.

FEMA's role is to provide planning guidance, technical assistance, and funding for establishing a RACES organization at the State and local government level.

### 1-9. Emergency Situations.

The RACES organization provides or supplements communications during emergencies where normal communication systems have sustained damage. It may be used in a wide variety of situations, including:

- a. Natural Disasters;
- b. Technological Disasters;

- c. Nuclear Accidents;
- d. Nuclear Attack;
- e. Terrorist Incidents; and
- f. Bomb Threats.

## **Chapter 2 - Eligibility and Procedures for RACES**

- 2-1. General
- 2-2. RACES Eligibility
- 2-3. Procedures for Establishing a RACES Organization
- 2-4. Recruitment and Retention
- 2-5. Training
- 2-6. Development of a RACES Plan
- 2-7. RACES Activation
- 2-8. RACES Unit Records

### **2-1. General.**

This chapter provides information on the requirements and procedures for establishing a RACES organization. Operator privileges in RACES are dependent upon the class of license held by the amateur.

### **2-2. RACES Eligibility.**

Any United States citizen, who possesses a valid FCC Amateur Radio Operator License, technician class or higher, is eligible to become a member of RACES. The services of amateurs who have a Novice Class license may be used, but this is not recommended due to the privilege limitations.

### **2-3. Procedures for Establishing a RACES Organization.**

The following procedures are to be followed for establishing a RACES organization:

a. To establish a RACES organization, the Director, State or local government Emergency Operating Center (EOC) or Director of Emergency Management (or designated representative) should first appoint, in writing, a reliable amateur to serve as the RACES Officer. This individual serves as a liaison between the RACES organization and the Director's office and assists in the development of the RACES organization, recruits members, and keeps the Director, EOC, informed of all RACES activities, progress, and needs.

b. The RACES Officer is a General Class Amateur, or higher, thoroughly knowledgeable of FCC Rules and Regulations and familiar with the functions of the Amateur Radio Relay League (ARRL) and the Amateur Radio Emergency Services of the ARRL. Individuals with strong organizational abilities, good verbal and written communications skills, and experience in emergency center operations are ideal candidates.

## 2-4. Recruitment and Retention.

a. Each prospective member completes a RACES Operator Application and returns it to the RACES Officer. The RACES Officer designs the application to meet local requirements. The application must not contain information that is protected under the Privacy Act. The RACES Officer recommends acceptance or nonacceptance to the Emergency Management Director. Once approval is granted, the Director prepares a letter designating the applicant as a certified RACES member. A photograph identification card for each RACES member is highly recommended.

b. In order to serve effectively as a volunteer member of the emergency staff, access to otherwise restricted areas, such as the EOC or the jurisdiction's communications center, may be associated with RACES participation and assignments. To the extent that similar requirements exist for other members of the emergency staff with access to restricted areas, a limited background check for RACES applicants is also recommended. This should be performed in accordance with the jurisdiction's regulations and procedures.

c. RACES members are responsible for:

1. Participating in the training sessions;
2. Briefing the RACES Officer of any changes in equipment or amateur status that may affect operation in the RACES program;
3. Developing a strong background in emergency procedures, FCC Rules and Regulations, and network procedures;
4. Being available when emergency communications are required by the appointing Director;
5. Helping strengthen the organization by offering suggestions and positive feedback to correct deficiencies;
6. Complying with volunteer standards established by the jurisdiction; and,
7. Notifying the RACES Officer, in writing, when terminating membership.

d. Membership participation should be evaluated every 2 years. If a member's participation is lacking, membership terminates; if deemed adequate, membership continues for another 2 years.

## 2-5. Training.

a. Training sessions should be scheduled to exercise the efficiency of the emergency plan and the proficiency of the RACES members. On the average 1 hour per week should be devoted to RACES activities and training.

b. RACES organizations may be utilized during drills and exercises in order to train members and exercise the emergency plan. RACES exercises will help with updates or revisions to the RACES plan. Special RACES drills and exercises serve as a mechanism for honing skills in emergency communications procedures in general and for training in any specific or unusual protocols used by the

jurisdiction. Periodic participation in full scale exercises is also beneficial in promoting familiarity with other elements of the jurisdiction's emergency plans and procedures the communications function must support.

c. All training must be recorded in the participant's and RACES unit's files.

## 2-6. Development of a RACES Plan.

a. Once membership reaches a strength that is considered adequate by the RACES Officer, bylaws and an emergency plan that meet local requirements must be written.

b. Development of a RACES plan is vital to the organization and its importance cannot be overemphasized. A plan must be prepared in accordance with the local area needs and the facilities available within that particular area. Written plans must clearly describe each area to be covered. All local government RACES plans are forwarded to the State disaster preparedness communications officer for coordination and retention. All State Government RACES plans are forwarded to the FEMA Regional Communications Officer for coordination and retention.

c. The following items should be addressed, at a minimum, within the plan and provisions made to cover them:

1. Identify the community or area where coverage is required;
2. Identify the type of support needed, i.e., shelter, communications, hospital, etc.
3. Identify the network to be used to provide each type of support, the operating frequency, mode of operation, and location of the network control station for each network;
4. Establish the RACES Unit's chain of command, identifying the emergency management organization's communications officer (or other official) to whom the RACES unit reports;
5. Identify frequencies--high frequency and very high frequency--to be used by the mobile, portable, repeater, and fixed stations;
6. Provide the addresses of all known fixed station locations required to support each network;
7. Define the areas of operation of mobile stations required to support each network;
8. Describe, briefly, the communications equipment required for portable, mobile, and fixed operations;
9. Describe, briefly, the communications equipment, antenna, and power source required for portable, mobile, and fixed operations;
10. Include a statement that states, "FCC Rules and Regulations apply to the operation of a radio in the amateur service and therefore apply to the RACES organization."

d. A checklist unique to the local requirements may be developed and incorporated into the plan. Testing and drills may be scheduled but must not exceed a total time of 1 hour per week.

e. The appendix provides an example of a local plan which may aid in the development of a local plan.

## **2-7. RACES Activation.**

a. RACES may be activated by the appointed Director of an Emergency Management Office, or authorized representative, for a particular area. The activation is in accordance with an approved civil defense communications plan in any emergency concerning the following:

1. Safety of life;
2. Preservation of property;
3. Alleviation of human suffering and need;
4. Any disaster endangering the public;
5. Act of sabotage; or
6. Testing and drills.

b. RACES stations and operators supplement surviving communications facilities, or provide emergency communications requirements.

## **2-8. RACES Unit Records.**

It is recommended that the Emergency Management organizations provide appropriate space and maintain custody of these records. The following records should be maintained by the RACES Unit:

- a. The jurisdiction's current RACES plan;
- b. Records of all RACES Unit activation, drills, and training;
- c. Individual RACES Unit member files, including application form, copy of license, and a record of participation in activation, drills, and training;
- d. Equipment manuals, with additional operating instructions, where appropriate. This includes equipment owned by RACES Unit members, but made available for common use (e.g., equipment including personal equipment on loan and installed in the EOC); and
- e. Additional records or other documentation, as required by the Emergency Management Office.

## Chapter 3 - Operations - War Time Emergency Situations and RACES Drills

- 3-1. General
- 3-2. List of Frequencies (Wartime Emergency Situations)
- 3-3. Message Format and Transmission Mode
- 3-4. General Limitations
- 3-5. Limitation on the Use of RACES Stations (Wartime Emergency Situations)

### 3-1. General.

This chapter provides information on the use of frequencies in emergency situations when the War Emergency Powers, under the provisions of the Communications Act of 1934, Section 606, as amended, have been invoked by the President.

### 3-2. List of Frequencies (Wartime Emergency Situations).

a. The frequency bands listed below are available to stations transmitting communications in RACES on a shared basis with the amateur service. In the event of an emergency that necessitates the invoking of the President's War Emergency powers under the provision of Section 706 of the Communications Act of 1934, as amended, only RACES stations and amateur stations participating in RACES may transmit on the following frequencies:

#### Frequency or Frequency Bands

##### KHz:

1800-1825  
1975-2000  
3500-3550  
3930-3980  
3984-4000  
7079-7125  
7245-7255  
10100-10150  
14047-14053  
14220-14230  
14331-14350  
21047-21053  
21228-21267

##### MHz:

28.55-28.75  
29.237-29.273  
29.45-29.6  
50.35-50.75  
52-54  
144.50-145.71  
146-148  
2390-2450

b. In addition, 1.25 cm (220.0-225.0), 70 cm (420.0- 450.0), and 23 cm (1240-1300 MHz) are available.

c. Frequencies at 3.997.0 MHz and 53.30 MHz are used in emergency areas to make initial contact with a military unit and for communications with military stations on matters requiring coordination.

### **3-3. Message Format and Transmission Mode.**

a. The RACES message format should parallel other communications services such as ARRL, United States Army Military Affiliated Radio System and/or FEMA.

b. Each message element should be defined to minimize confusion. In emergency communications, most messages are assigned immediate transmission precedence. The emergency communication individual must understand the order of transmission and the precedence governing its sequence. The following defines message precedence:

1. IMMEDIATE precedence messages are processed ahead of all other precedence messages and sent or delivered in the order of receipt.

2. PRIORITY precedence messages are processed in the order of receipt and processed after IMMEDIATE precedence messages and ahead of all ROUTINE precedence messages. PRIORITY precedence messages are sent or delivered in the order of receipt.

3. ROUTINE precedence messages are processed in the order of receipt and after the IMMEDIATE and PRIORITY precedence messages.

c. The mode of transmission should be selected to suit the emergency situation and to utilize the available communication resources. The mode must remain flexible in the emergency plan. To eliminate confusion, list modes in order of preference. The following are several recommended modes:

1. Voice Communications (telephone)-In most situations, voice fulfills the communications requirement. Use voice communications when a printed copy is not necessary.

2. Radio Teletype (ASCII/BAUDOT)-When printed copy is essential, select one of these.

3. Packet (High Frequency/Very High Frequency (VHF))- VHF Packet operation is synonymous with the transfer of information between amateur stations throughout the United States. Packet is an extremely accurate mode that could be used for most local emergency communications. Information may be passed between packet stations at high speed with complete accuracy. Packet is highly recommended when an accurate printed copy is required for an emergency operation.

c. Many other modes are available that could be used for emergency communications; however, the modes listed in subparagraphs 3-3c(1), (2), and (3) should be considered before other modes. Mode selection must be within the boundaries of FCC Rules and Regulations and the authorized modes for the frequencies listed in this plan. VHF frequency modulation could provide a reliable voice link between mobile units, pedestrians, and the EOC.

### **3-4 General Limitations.**

a. RACES stations operating in any of the frequency bands listed in this plan shall not cause harmful interference to other services that might share the frequencies.

b. All messages transmitted by a RACES station must be authorized by the emergency organization for the affected area.

c. All messages transmitted in connection with drills or tests are plainly identified as such by use of the words drill or test in the body of the messages.

### **3-5. Limitation on the Use of RACES Stations (Wartime Emergency Situations).**

a. While performing duties as a RACES operator, members may not communicate with amateurs who are not RACES members. Only emergency communications may be transmitted as defined in FCC Rules and Regulations. No amateur radio station shall be operated in the RACES unless it is certified as registered in a disaster service organization.

b. No RACES station shall be used to transmit or receive messages for hire, nor for communications for compensation, direct or indirect, paid or promised.

## **Appendix.**

### **RACES Service Plan for the Support of Local Government During Emergencies**

(Based on the plan developed at Tacoma, Washington)

To convert this plan for use in your community, replace the underlined portions of the sample plan with the information you compile in completing the worksheets, and provide annexes applicable to your community.

For statistical information purposes, it is requested that a copy of your community's amateur plan be sent to:

The FEMA region and the disaster services office you serve.

Limited planning assistance is also available by contacting the FEMA region that supports your state.

## **APPROVALS**

This plan has been reviewed and approved by the following authorities:

Defense Commissioner,  
Federal Communications Commission

FEMA Regional Communications Officer

State RACES Officer



Director  
Tacoma Department of Emergency Services

Chairman  
Washington State Emergency Communications Committee

Chairman, Tacoma/pierce County  
Operational Area Emergency Communications Committee

RACES Coordinator, Tacoma/pierce County  
Amateur Radio Support Group

## 1. Introduction.

a. **Scope.** This plan provides guidance for the Radio Amateur Civil Emergency Service (RACES) to support local government officials during certain emergency conditions.

b. **Purpose.** This plan is intended to provide coordinated operation between the City of Tacoma government officials and the RACES organization during times when there are extraordinary threats to the safety of life and/or property. Maximum benefits from a RACES organization can be obtained only through careful planning which identifies the organizations, agencies, and individuals concerned and assigns a definitive role to each. This plan enables agencies and organizations having emergency responsibilities to include the RACES organization in local emergency plans and programs.

c. **Operations.** This plan becomes official for the City of Tacoma Washington when signed by the Federal Communications Commission (FCC); Director of Emergency Services; Chairman of the State Emergency Area Emergency Communications Committee; and authorized RACES representatives. Under this plan, the Director of Emergency Services is empowered to request the use of Available volunteer communications facilities and personnel. Acceptance of or participation in this plan shall not be deemed as a relinquishment of license control, and shall not be deemed to prohibit an amateur radio service licensee or broadcast licensee from exercising independent discretion and responsibility in any given situation under the terms of its license.

## 2. Authority. Part 97 Subpart A, Federal Communications Commission Rules and Regulations.

3. **Authentication.** The form of authentication that will be used between the activating official and the RACES organization is personal identification or knowledge of the individuals involved.

4. **Identification.** The methods used to identify a RACES member and key personnel during a communications support operation are the following:

- a. Local Emergency Services Identification Card, and
- b. Personal Acquaintance.

## 5. Implementation Procedures.

a. **Procedures for Government Officials.** Upon notification or determination of an emergency condition or situation posing an extraordinary threat to life and/or property, **the City of Tacoma Washington Director of Emergency Services** will contact the RACES Liaison Officer.

The **Director of Emergency Services** will use the following format when contacting the RACES Liaison Officer:

This is **Lee Clark**, Director of the **City of Tacoma Department of Emergency Services**. I request that the RACES organization be activated for **Tacoma, Washington** because of (description of emergency situation).

In order to speed personnel activation during emergency conditions or provide other announcements, an authorized official may contact the Tacoma/pierce County Operational Area-emergency broadcast system station and request that a public service announcement be made to assist activation of the RACES organization.

Upon request of the emergency condition, a termination notice will be issued by appropriate government officials.

b. **Procedures For Amateur Radio Operators.** Upon request by authorized authorities, the designated RACES member(s) will report to the EOC and activate the required emergency nets using the frequencies below:

Shelter net 29.5 MHz USB

Evacuation net 146.52 MHz FM

Hospital net 223.5 MHz FM

RACES members missing a designated assignment by the EOC network control are encouraged to check in at any time.

In the event that assistance is offered by amateurs not living within the immediate area, amateurs will contact the EOC on the previously listed simplex frequencies or locally used repeater frequencies for assignment and dispatch.

At the cessation of the emergency, authorized officials initiate roll call from the EOC using any one or more of the previously listed simplex frequencies and local repeater frequencies. RACES members will then acknowledge and confirm receipt of termination message.

6. **Tests.** Tests of the system include:

a. One test per week of the RACES organization.

b. Annual emergency exercises.

7. **Annexes.**

a. Annex A: Lists Key personnel and their telephone numbers.

b. Annex B: Lists authorized RACES Radio Frequencies.

- c. Annex C: Lists RACES members and resources.
- d. Annex D: Functional block diagram of agencies that interface with the emergency organization.
- e. Annex E: Local Checklists.
- f. Annex F: Glossary of terms.

# New York State RACES Standard Operating Procedure

## Introduction

This manual is written to provide a standard of operation and a guide for training and message handling techniques and net procedures for Radio Amateur Civil Emergency Service (RACES) operators in New York State RACES Nets for state-wide nets as well as local county and city RACES nets. Instructions and general operating procedures presented in this Standard Operating Procedure (SOP) are applicable to message traffic handling by RACES and used in all RACES training. All amateur radio operators are encouraged to use this document in training and/or activated net operations. Proficiency is developed by practice using good procedures. Since message handling is the primary function of a RACES net, efficiency in this regard is the major goal toward which this SOP is directed.

## Description and Authority

RACES is an organization of Federal Communication Commission licensed amateur radio operators who volunteer to provide radio communications for state and local governments during times of emergency. Created in 1952 primarily to serve in civil defense emergencies, RACES provides essential communications and warning links to supplement State and local government agencies during emergencies.

**RACES is organized to provide emergency communications for civil preparedness purposes only.** RACES is a special part of the amateur radio service sponsored by the Federal Emergency Management Agency (FEMA), and is conducted by amateur radio operators using their primary station licenses or by existing RACES stations. In the event that the President invokes the War Emergency Powers Act, amateur radio operators enrolled with their local emergency management offices would become limited to certain frequencies, while all other amateur operations would be silenced.

**During an emergency, RACES is operated under the direct control of the local emergency management office,** as authorized by the Federal Communication Commission and the Director of the New York State Emergency Management Office.

RACES is authorized by Section 606 of the Communications Act of 1934 as amended by Part 97.407 of the Federal Communications Commission. A copy of part 97.407 is in the appendix. RACES guidance is also provided by FEMA document CPG1-15 March 1991. A copy of this document is available at the FEMA web site: [www.fema.gov/library/civilpg.htm](http://www.fema.gov/library/civilpg.htm)

NOTE: FCC rules, Part 97, still apply to all RACES stations and RACES operators participating in RACES operations.

## NYS RACES and ARES

ARES is the "Amateur Radio Emergency Service". This is the national amateur radio emergency preparedness organization sponsored by the American Radio Relay League (ARRL). This organization is completely different from RACES, although many goals are in common. In many cases, ARES will be used as a public service organization to assist with communications during non-emergency events such

as parades, foot and bicycle races, and community events. Membership in the ARRL is not required for amateur radio operator to be an ARES member. In general, ARES is organized to serve the public, and RACES is organized to serve the government. It is desirable for RACES members to also be enrolled in the ARES program. The additional training received during ARES public service events can be of great value during times of emergency. In addition to this, there are times of emergency when ARES will be the first organization to activate for communications assistance. As an emergency escalates, the local Emergency Manager may call for a RACES activation. At this time, with radio operators already activated, the operation can smoothly go from an ARES operation to a RACES operation. It must be noted that when this happens, the RACES members are now under the supervision of the County RACES Radio Officer and the County Emergency Manager, and are no longer directly involved with the ARES operation. At this point, operations will usually move to the EOC if the radio operators are not already there. It is suggested that one operator on each shift remain with the ARES operation to act as liaison between RACES and the non-RACES stations which may be involved supporting other agencies or organizations. Whenever possible, RACES and ARES communications should be on different net frequencies. Cooperation between the ARES and RACES organizations is of high importance, and cannot be understated.

### RACES Eligibility

Any United States citizen who possesses a valid FCC Amateur Radio Operator License, Technician Class or higher, is eligible to become a member of RACES. The services of amateurs who have a Novice Class license may be used, but this is not recommended due to the privilege limitations. All RACES operators are required to operate within the restrictions of their license class, as per FCC part 97.

### RACES Membership

**Membership in RACES is on a county level.** Individual members will register with the RACES Radio Officer of their county. The Radio Officer will provide a list of RACES members to the County Emergency Manager, who will approve the individual's membership in RACES. The County Radio Officer as well as the County Emergency Management Office will maintain this list.

**RACES members should be registered in one county only.** If a member is registered in more than one county, and there is a need for RACES volunteers in multiple counties, it would be impossible for individual county emergency managers to know the number of volunteers available.

### Insurance

**New York State does not now provide insurance of any type** (workman's compensation or otherwise) for RACES volunteers. The local county where the RACES member is registered may elect to provide insurance for RACES volunteers. This is solely at the discretion of each individual county's legislature or board of supervisors.

### RACES Activation

**All RACES activation must be through the appropriate civil defense (emergency management) office.** The statewide RACES high frequency net will be activated upon directions of the State RACES Radio Officer or other proper authority at the State Emergency Management Office (SEMO). Only the Senior Civil Defense Official (County Emergency Manager in most counties) or the person acting directly on behalf of this official has the authority to activate RACES on a county level.

### Location of RACES Operations

Since RACES serves the government with a means of supplemental communications, it is vital that **RACES radio operators be available at the Emergency Operations Center** or command post, as requested by the Emergency Manager. The Emergency Manager or the County Radio Officer will determine additional deployment of RACES operators. In most situations, RACES operators will be working "in the field", and not from their homes.

**No RACES volunteer will ever travel to any disaster site without prior approval of the Emergency Manager through the Radio Officer.** Travel into an area under a "declaration of emergency" may actually violate certain laws in effect by the declaration of emergency.

### Inter-County Operation

**As of this date, there is no statewide "Mutual-Aid" agreement for inter-county operation.** Any inter-county operational details must be determined between the counties involved. If a county has chosen to provide insurance coverage for RACES volunteers, it must be determined from the county's insurance carrier if the insurance will cover a RACES volunteer for "out-of-county" operation.

### New York State RACES Nets

A list of the HF RACES training nets is in the appendix of this document. Up to date information on HF as well as local VHF nets can be found on the New York State Emergency Management Office website: [www.nysemo.state.ny.us](http://www.nysemo.state.ny.us)

### Radiotelephone (Voice) Procedures

Specific instructions for the conduct of communications employing radiotelephone procedures are found in the appendix of this document. Departures from these procedures may result in confusion, and thus reduce accuracy and efficiency of message handling.

### Radiotelegraph Procedures

Currently, New York State is the only state still conducting a scheduled RACES net with the use of Morse code. This net will cease operations on January 1, 2000.

### Procedures for Other Digital Modes

Other digital modes such as Packet, Pactor, Pactor II, etc., may also be used for the transmission of RACES messages. **Due to the built-in error checking in these modes, plain language will be used at all times.** The use of Q-Signals and Prowords are to be avoided. If an error is made during a "keyboard-to-keyboard" digital transmission, the sending operator will send: "The following was sent in error", followed by the words sent in error. This will be followed by the words "correction follows", followed by the proper text. If an error is discovered in a message sent to a bulletin board, the message will be withdrawn if possible. If this is not possible, a subsequent message outlining and correcting the error will be sent.

**A message is not considered as delivered until the receiving station acknowledges receipt** of the message. A message left on a "public bulletin board" or a "personal bulletin board" is not considered as delivered until acknowledged by the station it was intended for. For this reason, "keyboard-to-keyboard" transmission is encouraged whenever possible.

### RACES Message Format

Effective January 1, 2000, New York State RACES must use the standard message form as used by the American Radio Relay League (ARRL) and the National Traffic System (NTS). Individual nets may, at the option of the net manager, use this format immediately. The use of the pre-printed ARRL Radiogram message form is suggested, but not mandatory. Specific instructions on this message form are in the appendix.

### RACES Training Sessions

RACES HF training nets will be held once each week as noted in the net schedule in the appendix of this document. This will be conducted to improve the efficiency and operation of net procedures and message handling,

The Net Control Station (NCS) of any RACES net involving more than 1 county will provide a weekly report of net activities to the State Radio Officer (This may be bi-weekly if the same station is NCS for both weeks). This report will include the following:

- Date and time of each training session.
- Roll call of all stations in the net, indicating NCS and assistant NCS.
- Copy of "drill" message sent.
- Any other remarks or comments deemed necessary by NCS.
- The time permitted for RACES training is listed in FCC Part 97.407 E 4.

### Net Control Station Duties and Authority

**RACES nets are directed nets, and will be treated accordingly.** The authority of the NCS extends only to the operation of the net on the air. However, within this scope, and while the net is in session, the authority of the NCS is absolute. It is the duty of the NCS to maintain strict discipline and adherence to standard operating procedures. The decisions of the NCS are final and its instructions must be strictly and immediately complied with.

The NCS will clear traffic within the net, and dispatch traffic to points outside the net as is required.

**The NCS derives authority from the State Emergency Management Radio Officer (or, in a local net, the County Radio Officer), and is responsible to that Officer for the conduct of the net.** The success or failure of net operations depends on keeping the net in order and operating swiftly and smoothly by use of the powers invested in the NCS for this purpose. The NCS may break into the net at any time, if it is the opinion that it is necessary to aid in the functioning of the net. NCS must keep a written record of all stations in the net and the traffic they have for transmission.

### Questions, Comments, and Updated RACES Information

Questions or comments regarding the New York State RACES program can be directed to the State Radio Officer via e-mail at the New York State Emergency Management Office web site. The internet address of the SEMO web site is: [www.nysemo.state.ny.us](http://www.nysemo.state.ny.us).

Net schedules and general information about the New York State RACES program will be found at this site [www.nysemo.state.ny.us/RACES/races.htm](http://www.nysemo.state.ny.us/RACES/races.htm).

# Final Examination

Complete this exam after you have completed Part 2. You must answer 75% of the questions correctly to pass this examination.

1. How is the word amateur defined?
  - a. incompetent individual
  - b. not working as a profession
  - c. less proficient than professionals
  - d. highly competent individuals
  
2. What agencies do the amateur radio operators normally serve?
  - a. U.S. military
  - b. Red Cross
  - c. National Guard
  - d. Corporations
  
3. What advantage does amateur radio have over other forms of communications?
  - a. depends on emergency power
  - b. independent of the telephone system
  - c. second best to cell phone communications
  - d. requires shorter antennas
  
4. What level does most amateur radio communications begin?
  - a. federal
  - b. state
  - c. local
  - d. international
  
5. What is ARES?
  - a. local government
  - b. federal government
  - c. private organization
  - e. county government
  
6. Are ARES members required to have a valid FCC amateur radio license?
  - a. yes
  - b. no
  
7. At what level is an emergency coordinator?
  - a. national
  - b. section
  - c. local
  - d. district



8. The ARRL SET is:

- a. a local exercise in emergency communications
- b. a national exercise in emergency communications
- c. held once every two years
- d. required by state government

9. Where does an ARES Mutual Assistance Team usually provides service

- a. mostly local
- b. mostly in affected areas outside the local area
- c. mostly in rainy areas
- d. mostly in hazardous areas

10 What is RACES?

- a. local government
- b. federal government
- c. private organization
- e. county government

11. If the President invokes his War Emergency Powers, who can operate?

- a. amateur operators with a valid FCC amateur license
- b. RACES operators on any frequency
- c. RACES operators on specified frequencies
- d. amateur operators on specified frequencies

12. During an emergency, should you transmit non-critical information?

- a. yes
- b. no

13. On CW, what emergency call is recognized?

- a. Emergency or Mayday
- b. SOS
- c. any call
- d. international call

14. On voice, what emergency call is recognized?

- a. Emergency or Mayday
- b. SOS
- c. any call
- d. international call

15. What mode will usually be the most practical for mobile operation?

- a. CW
- b. Voice
- c. Digital

16. What mode will usually give you the most range?

- a. CW
- b. Voice
- c. Digital

17. What mode will usually give you the most secrecy?
- a. CW
  - b. Voice
  - c. Digital
18. What is critically important when working with public officials and agencies
- a. getting the job done any way you can
  - b. being accepted by public officials and agencies
  - c. getting funding for equipment
  - d. demonstrating the cost effectiveness of amateur gear.
19. What is the national traffic system used for?
- a. handling telephone communications
  - b. handling amateur radio communications
  - c. handling police and fire communications
  - d. handling citizens communications
20. In the Incident Command System, what section does emergency communications come under?
- a. operations
  - b. planning
  - c. logistics
  - d. finance
21. Do amateur radio operators need to follow the chain of command during emergency operations?
- a. yes
  - b. no
22. In the Incident Command System, what section does the Communication unit provide?
- a. an action plan
  - b. tactical operations
  - c. support to meet incident needs
  - d. set objects and priorities
23. During emergency communications, how should you handle messages?
- a. speaking as fast as possible
  - b. speaking slowly and clearly
  - c. speaking in code
  - d. speaking in a foreign language
24. Which type of message should be given a higher priority?
- a. routine
  - b. priority
  - c. emergency
  - d. welfare
25. Does packet radio communications require a computer or terminal?
- a. yes
  - b. no

26. What is the TNC used for?
- a. enables the push to talk
  - b. enables the RS232 interface
  - c. interfaces between the computer and radio
  - d. controls the software
27. Is an antenna needed for packet operation?
- a. yes
  - b. no
28. In packet, what command is used to place the TNC into the command mode?
- a. [command] c
  - b. [control] c
  - c. [alterte] c
  - d. [shift] c
29. In packet, what command is used to place the TNC into the conversation mode?
- a. [command] convers or k
  - b. [control] convers or k
  - c. convers or k
  - d. [shift] convers or k
30. In packet, what should you enter after MY in the command mode?
- a. your name
  - b. your call sign
  - c. your location
  - d. your TNC code
31. In packet, what should you enter to connect to another packet station?
- a. connect {your name}
  - b. connect {their call sign}
  - c. connect {your call sign}
  - d. connect {their name}
32. In packet, is "C" equivalent to "CONNECT"?
- a. yes
  - b. no
33. In packet, what should be the first thing you enter to disconnect, while in the convers mode?
- a. disconnect
  - b. d
  - c. [control] c
  - d. [control] d
34. In packet, what is the command mode?
- a. a mode used to accept commands from the keyboard
  - b. a mode used to hold a conversation
  - c. a mode used to connect to another station
  - d. a mode used only during emergency communications

35. In packet, what is the convers mode?
- a. a mode used to accept commands from the keyboard
  - b. a mode used to hold a conversation
  - c. a mode used to connect to another station
  - d. a mode used only during emergency communications
36. In packet, what is digipeating used for?
- a. to connect the TNC to the computer
  - b. to connect directly to another station
  - c. to connect indirectly to another station
  - d. to connect to digital radios
37. In packet, a network node is used for?
- a. to connect to a worldwide network
  - b. to connect to a local network
  - c. to connect to another station directly
  - d. to connect to the internet
38. In packet, can you send and receive private mail?
- a. yes
  - b. no
39. In packet, what code is used to send NTS traffic?
- a. social security code
  - b. node call sign
  - c. zip code
  - d. FCC valid code
40. What is the first thing you should do during an emergency before volunteering?
- a. move as fast as you can
  - b. begin operating
  - c. be sure your family is safe
  - d. set up a net control station
41. Do you need to follow the chain of command during field operations?
- a. yes
  - b. no
42. What is very important during field operations?
- a. drink plenty of coffee
  - b. push yourself as much as possible
  - c. drink plenty of water
  - d. ignore personal requirements and get the job done
43. Who is the first person you should call to volunteer?
- a. emergency coordination / radio officer
  - b. the police department
  - c. the fire department
  - d. any served agency

44. What alphabet is used during the transmission of messages, such as call signs?
- a. plain English alphabet
  - b. ITU phonetic alphabet
  - c. ARRL alphabet
  - d. FCC alphabet
45. What equipment should you bring to a field operation?
- a. what your EC/RO recommends
  - b. what you think you will need
  - c. the maximum you can carry
  - d. the most cost effective equipment
46. What primary purpose does the volunteer handout serve?
- a. provides you with contact and technical information
  - b. provides you with an understanding of the incident
  - c. enables you to become a net control station
  - d. enables you to solicit volunteers
47. How much damage can a category 5 hurricane cause?
- a. minimal damage to vegetation
  - b. moderate damage to houses
  - c. extensive damage to small buildings
  - d. catastrophic building failures possible
48. How many volunteers are needed to cover 3 assignment locations?
- a. 12
  - b. 24
  - c. 36
  - d. 48
49. Who is not eligible to become a RACES member?
- a. any U.S. citizen, who possesses a valid FCC Amateur Radio Operator Novice license class
  - b. any U.S. citizen, who possesses a valid FCC Amateur Radio Operator Technician license class
  - c. any U.S. citizen, who possesses a valid FCC Amateur Radio Operator Advanced license, advanced class
  - d. any U.S. citizen, who possesses a valid FCC Amateur Radio Operator Extra license class
50. What is the average recommended amount of time devoted to RACES training per week?
- a. 1/2 hour
  - b. 1 hour
  - c. 1 and 1/2 hours
  - d. 2 hours

# Part 2

# Technical

# Packet Radio

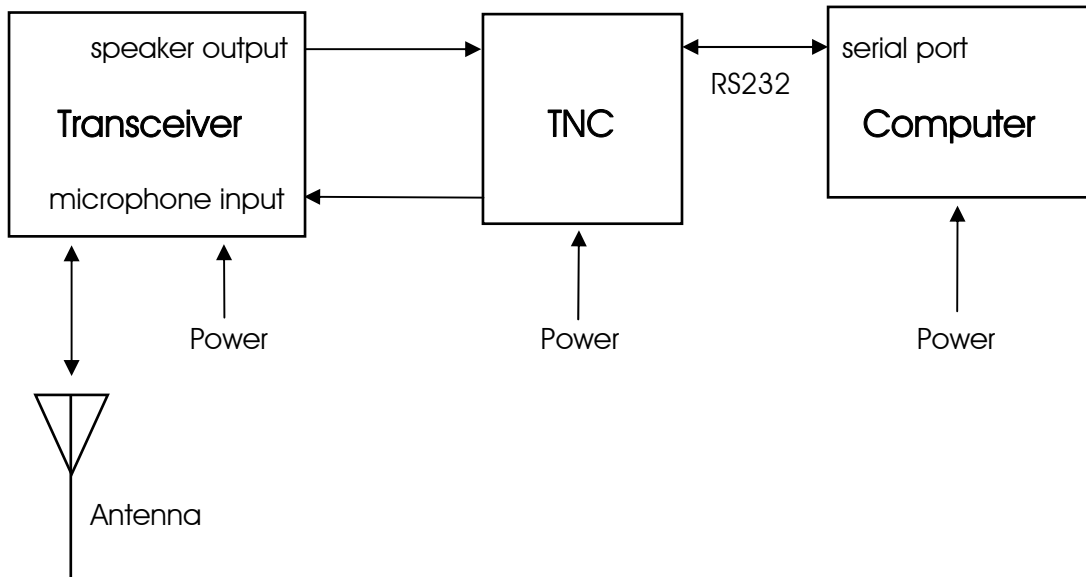

## Introduction

The equipment needed to get on the air is:

- Radio transceiver (without the microphone).
- Computer or terminal (probably none of the latter exist any longer).
- Terminal node controller (TNC).
- Appropriate interconnection cables.

There is packet activity on HF, but VHF is the best place to begin operating Packet Radio. The Terminal Node Controller (TNC). The TNC contains special firmware especially designed for Packet Radio. This "firmware" converts computer data into "packets" of digital information that can be sent (error free, via Packet Radio nodes) across the Packet Radio network. Some radios, such as the Kenwood TMD700A have a built-in TNC.

Keyboarding with friends over long distances is easy when using a Packet Radio Network. Very little power is needed, as the nodes along the network perform as "Automatic Routing" devices. The nodes do the "Automatic Routing" function automatically. The Packet Radio user only has to establish the connection. The rest is handled by the nodes.

## The TNC

A "Terminal Node Controller" (TNC) is similar to the modem used in computers. The TNC is used to interface the terminal or computer into the "RF" or radio (wireless) medium. Inside the TNC most

manufacturers have added some internal firmware called a "PAD." The pad or "Packet assembler/disassembler" captures incoming and out-going data and assembles it into "packets" of data that can be sent to and from a data radio or transceiver.

The PAD also enables the Push-To-Talk (PTT) circuits of the radio transceiver. When the enter key of the computer keyboard is pressed, the typed in data is sent out over the air to the target station or a nearby "store-and-forward" device known as a "node."

Incoming (received) data from the transceiver is also converted within the PAD, from Packets of data into a stream of usable data and sent to the TNC/modem. The data stream is then sent to the serial comport of the computer for display on the screen, or manipulated by a resident terminal program into on-screen text, pictures, or save-to-disk processing.

Usually an RS232 DB25 male to DB9 female cable is used to connect the TNC to the computer. The RS232 cable can be purchased. The TNC can connect to the radio either via the microphone connector or a separate data connector, which is usually a DIN connector. The microphone or data connector usually must be wired according to the manufacturers specifications.

There are TNC's and there are TNC's. A low cost TNC will work fine. However, you will need to put many control codes into it or use a software program that can add these codes. The more expensive TNC's have many control codes built-in. With built-in control codes, you can use simple software programs like "hyper Terminal," which is free with windows. In my station, I'm using the Kantronics KPC3 Plus and Hyper Terminal.

## **Transmit Level Adjustment**

The transceiver drive should be about 3 to 3.5 kHz. of deviation. This can be measured using a deviation meter if available. If not, check the manual of the transceiver for the packet audio input voltage (for the ICOM 207H it is 400 mV). Next, check the manual of the TNC for the procedure to adjust the output audio voltage of the TNC. If the appropriate equipment is not available, some trial and error may work.

## **Antenna Height**

If your attempting to work direct over long distances, without the use of a FlexNet Digi (Node) or a BBS, no antenna can be big enough nor high enough !

Using a well located Node or BBS is similar to voice operation through a repeater, wherein a handi talkie and rubber duck antenna is often sufficient.

## **Software**

A terminal program is needed to control the data going to and from the TNC and radio. Software can range from a simple DOS or Windows program to more sophisticated software that has logging and other functions. Some manufacturers include software with their TNC's.



There are two communication speeds that are used in Packet Radio 1200 Baud or 9600 Baud. Set the computer serial port to the speed of the computer serial port, usually 9600 Baud. Set the packet system speed to 1200 or 9600 Baud. ABAUD refers to the computer to TNC (serial port), and HBAUD refers to the RADIO or ON-AIR Baud rate (data speed).

There are a number of packet software packages available costing close to \$100. Personally, I don't like any of the ones I have tried. I like and use the "Hyper Terminal" program that is supplied with Microsoft Windows. Set Hyper Terminal for the com port you are using, which is usually COM1, the speed at which the com port works, which is usually 9600 bps, Data bits = 8, Parity = none, Stop bits = 1. After you complete the settings, save them as "Packet."

For those that prefer a more "user friendly" packet terminal for older PC's, DOS based "paKet" is excellent. Windows based WinPack (know in Europe as TPK) is also good. Any of these "shell" programs do greatly simplify the TNC commands that are detailed in the following paragraphs. They also enable you to multistream, such as remain connected to a DX Cluster while you check your mail and hold a keyboard to keyboard conversation with a friend!

## Packet Operation

Switch the transceiver ON and turn the volume up a quarter turn or just above the "9:00 o'clock position." Make sure the squelch is not set too tight. The squelch should be set to a position where the transceiver is quiet. The squelch is set in a similar manner that you would use for voice operation. When first turned on, the TNC you may display garbled text on the screen. This is usually because the terminal to TNC baud rate is not set to the same parameters. Some TNC's will do a "search" mode to find the proper settings.

Perform a "control C" [**Ctrl C**] (press Ctrl and the letter C at the same time) to place the TNC into the command (cmd:) mode. This is where all commands are made to and from the TNC. Any command that is typed while in the "cmd: mode is received by the TNC as a direct order. These codes can vary with TNC's.

Once in the command mode, press the [Enter] key. Each time the [Enter] key is pressed a "cmd:" prompt should appear on the screen. This is an indication that the computer has control (command) of the TNC.

**All commands must be followed by the [Enter] key.**

The next step will be to set the station call sign into the TNC. At the cmd: prompt, type:  
**MY (your call sign)**

Test the TNC to see if the station call sign is set into the TNC. To do so, type:  
**MY**

The screen should display a response from the TNC with:  
**MYCALL (your call sign)**

MYCALL NOCALL indicates that a call sign has never been set, or the internal memory battery has been disconnected or is dead.

To enter your call sign type:

**MY** (*your call sign*)

The TNC should respond with:

MYCALL (*your call sign*)

This indicates that the computer and TNC are communicating properly. If there is no response after typing MY, then try typing:

**ECHO ON**

The :cmd: should appear on the screen again, with a message similar to the following:

ECHO was OFF

If the computer is displaying double letters, (for example; MMY CCAALLL), this indicates that the ECHO command should be turned OFF. Type the following:

**ECHO OFF**

The TNC should respond with:

ECHO was ON

Below are some commands that should be made active:

**ECHO ON** (normal) or **ECHO OFF** (if double letters are displayed)

**MONITOR ON**

**MCOM ON**

**MCON OFF** (to display only packets addressed to you)      or **MCON ON** (to display all packets)

**MRPT ON**

If the RS-232 interface cable is wired using the RTS, CTS, Txd, Rxd, and Signal Ground leads, then set the XFLO command OFF. If the RTS, and CTS signals were not used, then make sure the XFLO command is ON.

Note: TNC's have 3 modes of operation: Command, Converse and Transparent. You must remain aware of which mode the TNC is in at any current moment!

### Command Mode

In the COMMAND mode, the TNC will interpret data received from the keyboard as a command to process data, not as data to transmit.

When you are in the command mode, the screen will display:

cmd:

Brief list of NEWUSER commands:

**CONMODE CONVERS** (TNC will automatically be placed into CONVERS mode after connection is established)

**CONMODE TRANS** (TNC will automatically be placed into TRANS mode)

**CONNECT** or **C** (connects to another station)

**CONVERS** (to enter convers mode)

**DAYTIME** (to read the time and date)  
**DAYTIME** yymmddhhmm[ss] (to enter the time and date)  
**DIGIPEAT ON** (turns digipeat on)  
**DIGIPEAT OFF** (turns digipeat off)  
**DISCONNECT** or **D** (disconnect from another station)  
**DWAIT** n (n=0-255) (10 times n in milliseconds) (delay used to avoid collisions between digipeated packets)  
**ECHO ON** (character received from the keyboard are echoed back to the screen)  
**ECHO OFF**  
**HELP** (for most TNC's will generate a list of commands)  
**INTERFACE NEWUSER** (for most TNC's will enter standard terminal mode with a limited command set)  
**INTERFACE TERMINAL** (for most TNC's will enter terminal mode with full command set)  
**MCOM ON** (monitors all packets being transmitted)  
**MCOM OFF**  
**MCON ON** (will display all packets received)  
**MCON OFF** (will display only packets addressed to you)  
**MHEARD SHORT** (short list of stations heard \* indicates digipeating)  
**MHEARD LONG** (long list of stations heard)  
**MHEARD CLEAR** (clear the list of stations heard)  
**MONITOR ON** (unconnected packets will be seen. Also acts as a master control for MALL, MCOM, MCON, MRESP, MRPT)  
**MONITOR OFF**  
**MRESP ON** (monitors packets including AX.25)  
**MRESP OFF**  
**MRPT ON** (entire digipeat list is displayed)  
**MRPT OFF**  
**MYALIAS xxxxxx-n** (n= 0-15) (sets TNC to an alias call sign for digipeating)  
**MYCALL xxxxxx-n** (n=0-15) (sets TNC for you call with the optional supplementation Station Identifier (SSID))  
**NOMODE ON** (TNC does not change modes after a connection is established)  
**NOMODE OFF** (TNC will change to whatever mode is established in CONMODE after a connection is established)  
**TXDELAY** n (n=0-255) (delays transmit to give your radio enough time to reach full power, set delay to 10 times n in milliseconds) (300 ms is commonly used)  
**UNPROTO CALL VIA W2ABC,W2CDF,W2EFG** (max 8 call signs)

### Convers (Conversation) Mode

In the CONVERS mode, the TNC will interpret data received from the keyboard as data to be transmitted. Most TNC's will automatically switch to the CONVERS mode after a connection has been established. When you are in the COMMAND mode, you can switch to the CONVERS mode by giving the command:

**CONVERS** or **K**

If you are in CONVERS mode and want to switch to COMMAND mode, type:

**[Ctrl] C**

### Trans (Transparent) Mode

A second method for transmitting data, called TRANS mode, is to instruct the TNC to ignore "control characters," such as "backspace," and transmit every character as data. For many TNC's TRANS mode is a TERMINAL mode not a NEWUSER mode.

If you are in TRANS mode and want to switch to COMMAND mode, type:  
**[Ctrl] C** three times with a pause of less than second between entries

### Monitoring or Calling CQ

If you turn the MONITOR command on, you will see other packet stations on your screen. You will see two call signs at the beginning of each packet separated by a ">" The first station is the station that is sending the packet. The second is the station receiving the packet.

To call CQ, you must be in the CONVERS mode, so that the data received from the keyboard will be interpreted as data to be transmitted.

To enter the CONVERS mode, type:  
**CONVERS** or **K**

Anything you type at this point, will be transmitted.

Example:  
**W2XYZ CQ CQ CQ**

If a station wants to connect to you, they will type the **CONNECT W2XYZ** command

To return to the COMMAND mode, type:  
**[Ctrl] C**

### Packet Direct

The most common frequency for packet communications is 145.010 mhz at 1200 Baud.

Begin in the command mode:  
**[Ctrl] C**

Enter your call sign into the TNC  
**MY** (*your call sign*)

Test that the TNC has received your call sign:  
**MY**

The screen should display a response from the TNC with:  
**MYCALL** (*your call sign*)

To connect directly to W2XYZ, assuming you both have a direct path:  
**CONNECT W2XYZ** or **C W2XYZ**

If the TNC receives an acknowledgement of connection it will display:

\*\*\* CONNECTED TO W2XYZ

Once connected, the TNC should automatically switch to conversation mode (CONVERS). You can type in text, then press enter to send. You should automatically receive text from the station you are connected to.

When you have completed your conversation, you need to get back to COMMAND mode to sign off.

To get back to COMMAND mode, type:

**[Ctrl] C**

To disconnect, type:

**DISCONNECT** or **D**

The TNC should respond with:

\*\*\* DISCONNECTED

## Digipeating

The original implementation of Amateur Packet Radio 20 years ago was through the use of Digipeaters. The concept being that each and every station would enable their "Digi" as a shared resource, and users could step their way employing intermediate Digi's to reach a friend beyond the range of either of their own stations.

While this method has been surpassed by intelligent network "nodes", it still has merit for emergency communications purposes. Amateurs should still learn how to use the "digi" function within their TNC's.

Every Amateur Packet Radio station can be a Digipeater by simply turning on the Digipeat command, which is:

**DIGIPEAT ON**

A station that turns on digipeating will retransmit any packet that is received that contains the MYCALL or MYALIAS in the digipeat list of address.

Example:

Sending station is KB2SEN and receiving station is KB2REC.

Stations KB2A, KB2B, and KB2C all have digipeat turned on.

The geographical layout of the stations is KB2A, KB2B, and KB2C. In order for KB2SEN to be able to reach KB2REC, KB2SEN has to transmit to KB2A, then KB2A has to transmit to KB2B, then KB2B has to transmit to KB2C.

The connect command for KB2SEN to connect to KB2REC would be as follows.

### **C KB2REC VIA KB2A,KB2B,KB2C or C KB2REC V KB2A,KB2B,KB2C**

The return path for KB2REC to KB2SEN is automatic. Once the connection is made, KB2REC only has to type the reply and press enter to send a packet back to KB2SEN. KB2REC's TNC will reverse the path back to KB2SEN.

Note: Due to Packet Radios structure no more than 8 digits can be used.

When you have completed your conversation, you need to get back to COMMAND mode to sign off.

To get back to COMMAND mode, type:  
**[Ctrl] C**

To disconnect, type:  
**DISCONNECT or D**

The TNC should respond with:  
**\*\*\* DISCONNECTED**

### **Network NODES**

"Nodes" are a vast improvement to the original "digi" scheme. They have gone through many evolutions, starting with the original NETROM, to it's clones TheNET, G8BPQ and MSYS, and finally onto a newer networking protocol called FlexNet. All nodes on Long Island, and most in the surrounding area, now employ the newer faster intelligent FlexNet protocol. Other networking protocols such as ROSE and FPAC never existed in our local area, while use of TCP/IP has faded greatly.

Note, while NETROM and it's clones called a Network Node simply a "NODE" FlexNet, which was developed in Germany called them "DIGI's" based upon the German name for a "Digital Repeater". A "FlexNet DIGI" is what we call a "NODE", not the "digi" described in the digipeating section.

Many packet radio "NODES" connected to the worldwide network exist Long Island:

WA2PNU (144.990 MHz, at 1200 Baud, Huntington)  
(M or C WA2PNU-4 for BBS)

WB2CIK (145.07 MHz, at 1200 Baud, West Hills)  
(M or C WA2PNU-4 for BBS)  
(C WB2CIK-14 for DX Cluster)

NY2LI-8 (145.03 MHz, at 1200 Baud, Hauppauge)

NY2LI (145.05 MHz, at 1200 Baud, Yaphank)

N2NEI (145.07 MHz, at 1200 Baud, Southampton)  
(M or C N2NEI-4 for BBS)

K1IMD-2 (144.99 MHz, at 1200 baud, Jamesport)  
(M or C N2NEI-4 for BBS)

KC2COJ (145.05 MHz, at 1200 baud, Far Rockaway)  
(M OR C KC2COJ-4 for BBS)  
(C KC2COJ-1 for TCP/IP Router)

NY2S (145.09 MHz, at 1200 baud, Lynbrook)  
(M or C NY2S-4 for BBS)

Frequencies from 144.91 to 145.09 MHz on 2 M, and 441.00 to 441.10 MHz on 70 CM bands are set aside for packet use. There is some additional activity in the 145.59 to 145.69 MHz segment too.

### Long Island FlexNet Site Information

This 10 Port FlexNet 3.3g Digi is located in West Hills, LI, NY, USA

The FlexNet runs on a 66 MHz 486DX with 9 RS-232 Ports. Each port in turn interfaces with a TNC running 6PACK firmware, thus off-loading some of the AX-25 protocol burden from the main computer.

The following Servers are immediately available:

Bulletin Board: WA2PNU-4    DX Cluster: WB2CIK-14

SysOp is John C Papson, WB2CIK @ WA2PNU.#NLI.NY.USA.NA

Updated Northeastern USA FlexNet info can be found at [www.northeastflexnet.org](http://www.northeastflexnet.org)

Port	Baud	Frequency	Function
0	1200	145.07	User access at 1200 baud
1	9600	145.59	User access at 9600 baud
2	19200	434.95	Link to Valhalla NY & Alpine NJ
3	9600	420.85/421.175	Link to Far Rockaway NY
4	9600	428.875	Link to Putnam NY
5	9600	421.95	Link to Orange CT
7	1200	50.73	Link to Jamesport NY & Yaphank NY
8	1200	223.54	Link to Huntington NY & Hauppauge NY
9	1200	441.075	User access at 1200 baud & BBS forwarding
10	9600	null-modem	Link to DX Cluster computer

This site has long-term emergency power.

### Connecting through a Node

1) To connect to W2XYZ thru node WA2PNU, assuming both stations are listening to WA2PNU node:

**C W2XYZ V WA2PNU**

2) To connect to W2XYZ thru node NY2LI, assuming your listening to WA2PNU node and W2XYZ is listening to NY2LI node:

### **C W2XYZ V WA2PNU NY2LI**

3) To connect to W2XYZ thru distant node K2JFK (Clay NY), assuming your listening to WA2PNU and W2XYZ is in Clay NY listening to node K2JFK:

**C W2XYZ V WA2PNU K2JFK**

4) Above examples are from a disconnected state. You can connect first to your local node, C WA2PNU, and then the WA2PNU call can be deleted from the previous examples, such as:

1) **C W2XYZ**

2) **C W2XYZ V NY2LI**

3) **C W2XYZ V K2JFK**

5) To find out what node W2XYZ is monitoring, on an ARRL section by section basis, you connect to any node within that section, and then do a "find".

Example:

**F W2XYZ**

6) "A" command on any FlexNet will give a manually built list of nodes with geographic locations. Some sites have newer updates than others. "D" gives the machine made <D>estination list, showing callsigns, SSID range, and "round trip times" of other nodes. The D list will always be up to date! Nodes with RTT's under 1000 should be easily connected to, over about 1000 means the path may be dropping out due to propagation conditions.

Example (with your radio set to 145.07 MHz):

**C WB2CIK**

\*\*\* CONNECTED to WB2CIK

PC/FlexNet V3.3g West Hills, LI, NY, USA

1200 baud 145.07 9600 baud 145.59

SysOp John C Papsen WB2CIK @ WA2PNU

"C WB2CIK-15" to reach me at home keyboard

<C>onnect <D>estinations <F>ind <H>elp <I>nfo <MH>eard <P>orts <Q>uit <U>ers

<A> for Callsign vs Location Table <M>ail will connect to the nearest BBS

### **Disconnecting from a node**

**Q** for <Q>uit on FlexNet nodes, remember command is **B** for <B>ye on FBB BBS's!

### **Bulletin Board Servers**

Bulletin Boards are a "Store and Forward" device. Once you post your message or bulletin, the server stores it and then passes it on to the neighboring BBS's.

Typically, Personal messages and NTS traffic are forwarded instantly, wherein Bulletins may be delayed until off peak hours as not the tie up the network.

### **Connecting to a BBS**

BBS's usually are co-located with a Node. But not all Nodes have a BBS.



The nodes usually have the path a BBS programmed in. The M command will connect you to the BBS (<M>ailbox).

Users can either connect to their nearest Node, and then connect onward to the BBS, or just connect directly to the BBS itself.

Example:

Starting on 144.99 MHz, **C WA2PNU**, then **M**.

Or starting on 144.99 MHz, just **C WA2PNU-4**

Starting on 145.07 MHz, **C WB2CIK**, and then **M**, will also connect you to WA2PNU-4 BBS!

Example:

**C WB2CIK**

\*\*\* CONNECTED to WB2CIK

PC/FlexNet V3.3g West Hills, LI, NY, USA

1200 baud 145.07 9600 baud 145.59

SysOp John C Papson WB2CIK @ WA2PNU

"C WB2CIK-15" to reach me at home keyboard

<C>onnect <D>estinations <F>ind <H>elp <I>nfo <MH>eard <P>orts <Q>uit <U>ers

<A> for Callsign vs Location Table <M>ail will connect to the nearest BBS

**M** (command is short for <M>ailbox)

link setup...

\*\*\* connected to WA2PNU-4

[FBB-7.00g-AB1FHMRX\$]

WA2PNU BBS, QTH FN30HU.

Hello John, you are now on channel 1.

Here are 864 active messages, 229214 is last message and 228445 is the last you have listed.

Assigned channels:

Ch. 1 (FLEX) : WB2LUA-0 - MSP WB2CIK

on 01/04/02 10:43

via : WA2PNU-0 WB2CIK-2

Ch. 2 (FLEX) : KB2VLX-4 - Mon 01/04/02 10:42

via : WA2PNU-0

(2) WA2PNU BBS (H for help) >

Abbreviated list of available FBB BBS commands:

**A** Abort - Abort listing.

**B** Bye - Log off the BBS.

**H** Help - Help.

**K** Kill - Kill messages.

**L** List - List messages.

**M** Make - Copy a message to a file.

**N** Name - Change your name.

**NQ** Your Home QTH, "City, ST"

**NZ** Zip - State your zip-code.

**NH** homeBBS - Type your home-BBS.

**O** Option - Select options (paging, language, list/read personal etc).

**ON 123** will set the three most significant digits to 123, so you can read messages by only using the last 3 digits.

- R** Read - Read messages.
- S** Send - Send messages.
- X** Expert – Shortens the command prompt line

### Supplemental Identifier (SSID)

By adding -0 to -15 after your call sign, the operator can use their call sign 16 times.

### Types of messages

There are three basic types of messages, Personal (P), Bulletin (B), and NTS Traffic (T).

Personal messages are from one user to a second user, while Bulletins are from one user to a group of users in a designated area.

The difference being that (P) messages route only to the intended recipients home BBS while (B) bulletins flood every BBS in the designated area.

Example:

A bulletin may be sent to TRIBBS, NEBBS, NYBBS, CTBBS, USBBS or WW, meaning respectively the Tri-State Metro area, New England BBS's, New York BBS's, Connecticut BBS's, BBS's throughout the USA, or BBS's throughout the entire World.

NTS traffic is third party mail, forwarded via Postal ZIP codes. It is routed to the nearest BBS's to the third parties street address.

### Listing messages

The following commands are used to list messages

**L** lists every message on the BBS, back to the marker of the previous last message you listed. Beware that this command will list the last couple weeks or more of messages (think in terms of several thousand) the first time you long on to a BBS as a new first time user.

**LL ##** lists the last ## number of messages. Again this command will list (P), (B) and (T) messages.

**LM** Will list (P) messages only addressed to you

**LB** will list only (B) bulletins

**LT** will list only (T) NTS traffic

**LS** (subject) will list messages containing the subject in message title

Example:

LS DX will list every message with "DX" in the title.

## Receiving a Message

**R ###** where ### is the message number will give you the text of that message, be it (P) (B) or (T).

With (P) mail, it is polite to kill any message you have received and read with either the **K ###** or **KM** commands.

**K ###** will kill one message, as specified by the number ###

**KM** will kill all messages addressed to you.

In the case of NTS traffic, once you have delivered the message, it is proper to log back onto the BBS and kill that message.

## Receiving Private Mail

**RP** (Receive Private) or **R ###**, where ### is the message number

**KM** (Kill Message) to delete the current message

To Send a Reply:

**SR** (Send Reply) or **SR ###**, where ### is the message number

## Sending Private Mail

**SP K2HAM** (Send Private)

Routing (from WP) to K2JFK.#CNY.NY.USA.NOAM.

{White Paper (WP) server transparently learns users home BBS address's from traffic passing through each BBS, and in turn automatically shares this information between BBS's}

Enter the title for this message to K2HAM

**Text Message**

Enter the text for the message, end with Ctrl-Z or /EX on a blank line)

**Hello test, 1 2 3 4 5 6 7 8 9 10**

**73 de Jose**

**/ex** {Always end with /EX on a new line}

Mid: 32607\_WA2PNU Size: 85 bytes

WA2PNU BBS (H for help) >

An (P) mail address must follow this format:

K2HAM@K2JFK.#CNY.NY.USA.NOAM

^ addresses call sign

^ addresses home BBS

^ supplemental geographic info (often ARRL Section)

^ State

^ Country

^ Continent

### Sending a Bulletin

**SB RACES @ TRIBBS** (Send Bulletin)  
(this bulletin will flood all the BBS's in the Tri State area)

Enter the title for this bulletin:  
**Monday Nights Test Message**

Enter the text for the message, end with Ctrl-Z or /EX on a blank line)  
**Hello test, 1 2 3 4 5 6 7 8 9 10 from the EOC in Huntington, LI, NY.**  
**73 de Jose, RACES Officer, Huntington**  
**/ex** {Always end with /EX on a new line}

Mid: 32607\_WA2PNU Size: 185 bytes  
WA2PNU BBS (H for help) >

### Sending NTS TRAFFIC

When the message is ready to be entered into your local BBS, you must use the **ST** command, which means "Send Traffic", followed by the zip code of the destination city, then **@ NTS** followed by the two letter state abbreviation. The form used is:

**ST ZIPCODE @ NTSxx** (send NTS traffic)

Example:

A message being sent to Boston, MA 02109 would be entered as follows:  
**ST 02109 @ NTSMA**

Enter the title for this bulletin:  
**Test Message**

Enter the text for the message, end with Ctrl-Z or /EX on a blank line)  
**Hello test, 1 2 3 4 5 6 7 8 9 10 from the EOC in Huntington, LI, NY.**  
**73 de Jose, RACES Officer, Huntington**  
**/ex** {Always end with /EX on a new line}

Mid: 32607\_WA2PNU Size: 185 bytes  
WA2PNU BBS (H for help) >

To Send a Reply:

**SR** (Send Reply) or **SR ###**, where **###** is the message number

### Disconnecting from the BBS

**B** for <B>ye on FBB BBS's, remember command is **Q** for <Q>uit on FlexNet Nodes!

You have been connected 5mn 14s - Computer-time: 9s  
Bye, John, and welcome back.  
\*\*\* reconnected to WB2CIK

## APRS: Automatic Position Reporting System

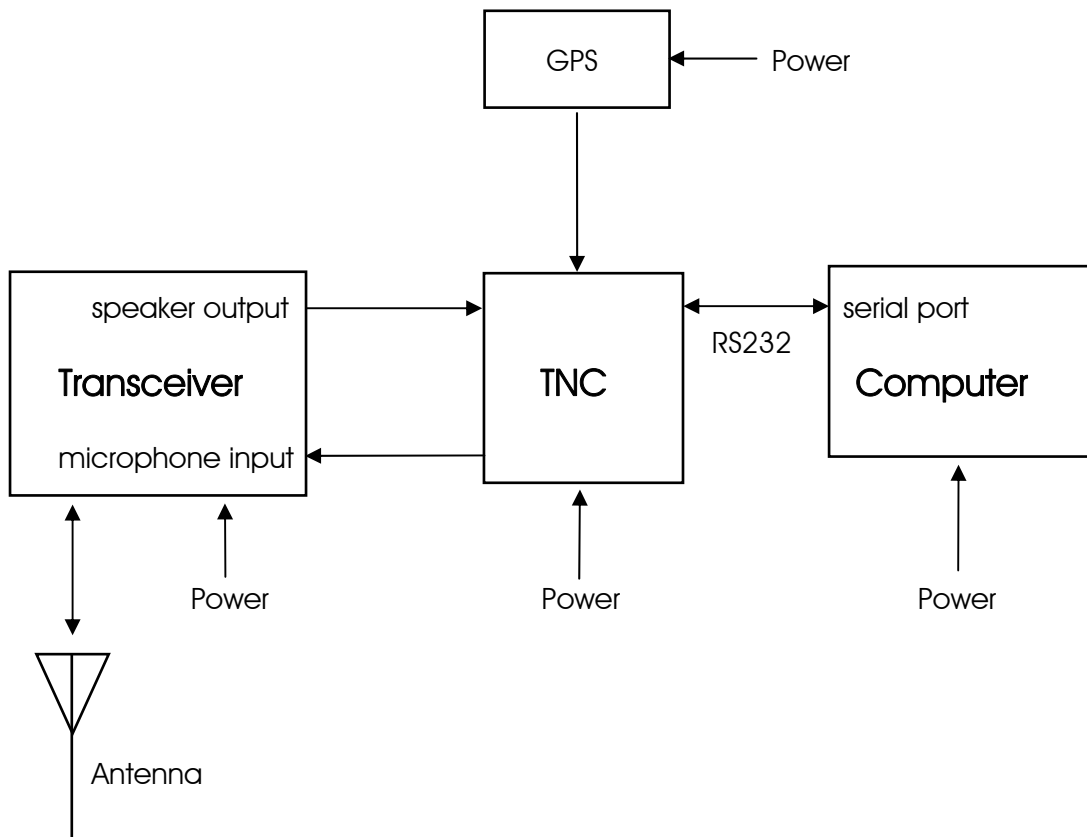

Automatic Position Reporting System (APRS) is a packet radio system used for tracking objects, people, vehicles, boats, aircraft, manned/unmanned balloons, weather systems, etc. APRS uses an Amateur Radio mode called unconnected (UI) packets.

APRS was developed by Bob Bruninga WB4APR, and was first introduced to the Amateur Radio Community at the ARRL Computer Networking Conference in New Jersey in 1992. Over the past 10 years APRS usage has grown and expanded across the globe. Many new features and capabilities have been added since its inception. Worldwide, there are over 4000 stations on the map at any one time. There are a number of software programs that can be used to identify and track APRS stations (beacons). I like IU-View32, which works with Street Atlas 9 maps. APRS beacons can also be tracked via the internet at [www.findu.com](http://www.findu.com) and [www.openaprs.net](http://www.openaprs.net).

Basically, APRS is a packet system with the addition of a GPS (global positioning system) receiver. Many TNC's have GPS receiver inputs. There are stand alone GPS devices, which have map displays and tracker GPS units, which do not have map displays and are less expensive. GPS coordinates can also be manually entered into an APRS system. This is often done with fixed station operation. Weather stations can be interfaced with APRS to report live and up to date weather information over an APRS network.

There are several vhf radios and handi talkies that have built in TNC's and GPS receiver inputs. These types of radios allow you to automatically transmit an APRS beacon and use voice mode without changing any settings.

The universal frequency used for APRS is 144.390 MHz.

During emergencies, APRS can be very valuable. APRS can be monitored at an emergency operations center to track emergency response teams, mobiles, etc. Responders in the field can also see their own location.

QRM is a major concern in packet and APRS. It is important to use the minimum number of hops to get your message through. If you are a home station and know the digipeaters in your area, then program a specific path. For example: K2ABC, K2ABCD. Home stations should not usually use more than RELAY,WIDE. Mobile packet stations have about half the range than voice mode.

If you are a mobile, you should not need more than 2 to 3 hops. Mobiles usually use the path RELAY,WIDE because they may be out of range of a WIDE digipeater, but be near someone's home station acting as a RELAY. Wider ranges can be achieved by using the RELAY,WIDE,WIDE path.

In 1994, the WIDEn-n capability was incorporated in the Kantronics TNC's. The WIDE-n-n digipeater repeats any packet with the address of WIDEn-n, but only once. It keeps a copy of the last 30 seconds of packets, and compares each new packet that hears these last ones to avoid duplication. This method eliminates the multiple looping of packets caused by multiple generic paths such as WIDE,WIDE,WIDE, which can be as many as 21 copies. In a WIDEn-n network, there would only be three packets outward bound 3 hops.

The "n" in the WIDEn-n path indicates the number of hops. Each digipeater that repeats the packet, decrements the WIDE-SSID by one. So the -n decrements to zero, but the WIDEn portion indicates the original number of hops so that recipients know how far it traveled. A long distance traveler or special event of wide interest may use up to WIDE5-5 but a local commuter may only want to use WIDE2-2 to limit QRM. The advantage of the WIDEn-n routing is that every packet still only has one digipeater call.

It is important to know the first digipeater that a packet hit, not the last. Users should begin all packets with WIDE,WIDEn-n so that the first digipeater does a call sign substitution and the packet arrives as FIRST,WIDEn-n.

The Global Positioning System is maintained by the U.S. Department of Defense and consists of 25 satellites in orbit around the earth. Positioning information is determined by a small receiver which measures the time in micro-seconds that it takes to receive the broadcast from between 1-12 satellites. By receiving the signal from at least four satellites, position information down to about 10 meters can be determined. Altitude information can also be obtained from the system. In mobile situations you can determine speed and direction.

## APRS Symbols and SSID Extensions

<u>SSID</u>	<u>Symbol</u>	<u>NWAPRS Station Type</u>
-0	Dot	Home Station
-1	Ambulance	Home PBBS
-2	Bus	
-3	Fire Truck	
-4	Bicycle	
-5	Yacht	
-6	Helicopter	
-7	Aircraft	TH-D7 Station
-8	Ship	Secondary Automobile
-9	Car	Primary Automobile
-10	Motorcycle	Primary WIDE
-11	Balloons	Secondary WIDE
-12	Jeep	
-13	RV	
-14	Truck	
-15	Van	TCPIP Only

## UIView Software

The UView software displays APRS positions on a computer using a TNC and Radio. It can also be used to send out a beacon from a fixed station without using a GPS device.

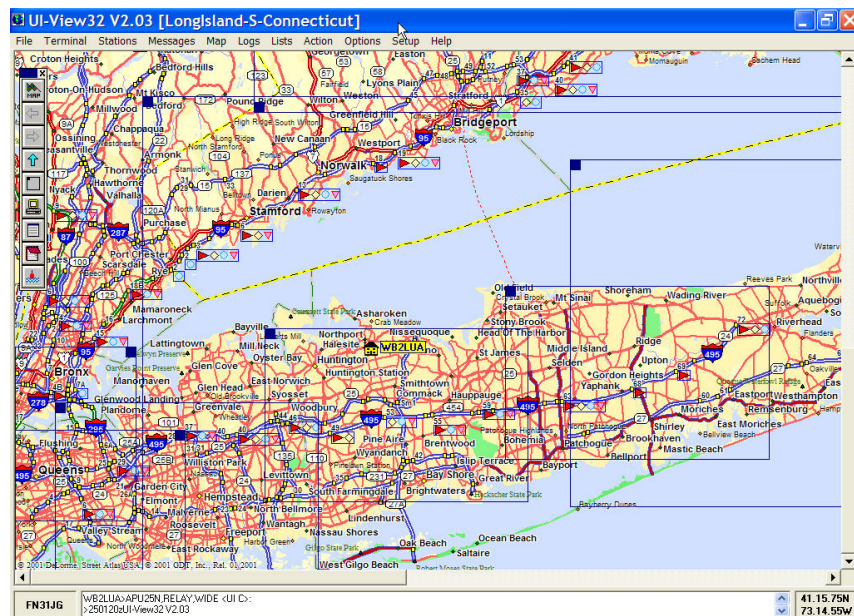

Below are some commands that should be made active:

ECHO ON (normal) or ECHO OFF (if double letters are displayed)

BEACON EVERY 0 (to manually enter beacons at base station)

MONITOR ON

MCOM ON

MCON OFF (to display only packets addressed to you) or MCON ON (to display all packets)

MRPT ON

### Kenwood - AvMap



The Kenwood TM-D710A is a 50 watt VHR/UHF mobile transceiver that can receive and transmit APRS signals. The position coordinates along with APRS text information are reported on the Kenwood screen. Add the AvMap G5 GPS unit to the Kenwood and those positions will be reported on the map display. The AvMap G5 supplies the cables that required by the Kenwood transceiver. This system is ideal in the field during emergencies. The managers will be able to see operator positions without the need of a computer.

### TinyTrak3Plus - GPS Mouse



An inexpensive transmit only GPS system that may be used is the Byonics TinyTrak3Plus and GPS mouse antenna for only \$112.



## Internet

APRS signal reports can be found on the internet. At findu.com a specific call sign can be tracked anywhere in the country by simply adding the call sign to the url as seen below. At openaprs.net APRS signal reports can be found by zip code.

## Resources

[www.kenwoodusa.com](http://www.kenwoodusa.com)

[www.byonics.com](http://www.byonics.com)

[www.avmap.us](http://www.avmap.us)

[www.openaprs.net](http://www.openaprs.net)

[www.findu.com/cgi-bin/find.cgi?call=WB2LUA](http://www.findu.com/cgi-bin/find.cgi?call=WB2LUA)

[www.ui-view.org](http://www.ui-view.org)

## Phase Shift Keying (PSK) Radio

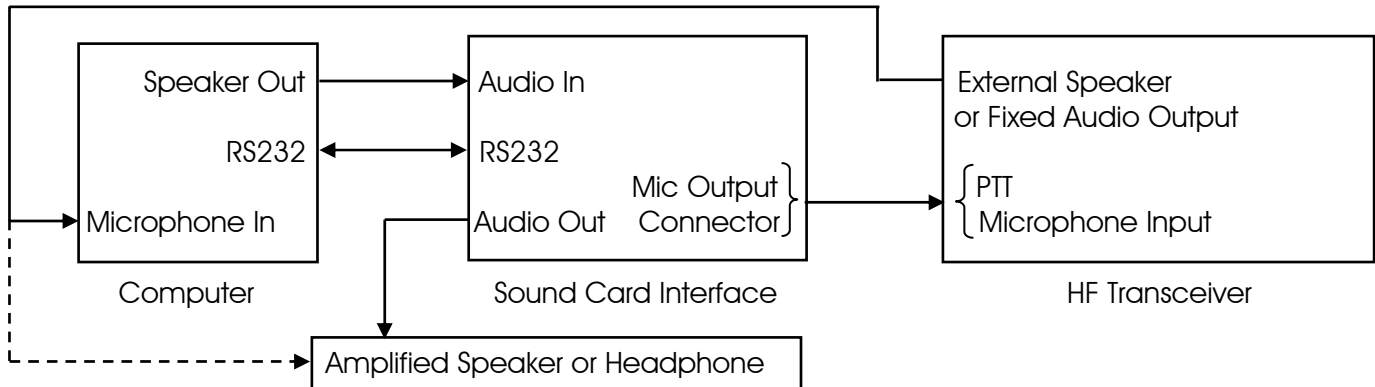

PSK31 (Phase Shift Keying) is a data mode that uses a personal computer and sound card to communicate. Packet is primarily designed for communications between two people or bulletin board. PSK31 is designed for multiple users like the voice nets. Anyone listening can see what everyone else is sending. PSK31 had many advantages over other modalities, such as requiring lower transmit power and more immunity from noise and interference (QRM). It uses an alphabet that has a text speed of 50 wpm. It does not require any handshaking with a second station. Roundtable communications are common in PSK31 mode. PSK31 was developed by Peter Martinez G3PLX.

The information in PSK31 is transmitted in patterns of reversed-polarities or 180-degree phase shifts. Phase modulation has several advantages over CW, which uses on-off keying. In a noisy or distorted propagation environment, the amplitude of CW will shift and vary much more than the phase of a signal.

The baud rate is 31.25 and the bandwidth is 31 Hz using narrow CW filters. The normal bandwidth of other modes is approximately 300-500 Hz. PSK31 can be used with lower signal levels in a crowded digital band. PSK31 operates in a much narrower bandwidth than FSK (Frequency Shift Keying).

PSK63 is a variation of PSK31. It has a bandwidth of 63 Hz and a speed of 100 wpm. RTTY has a speed of 60 wpm. PSK63 has improved polar path performance over PSK31.

The difference between a CW filter of 500 Hz and the bandwidth of PSK31 of 31 Hz ( $10 \cdot \log(500/31) \text{ db} = 12 \text{ db}$ ) is 12 db, which demonstrates that a CW transmitter must transmit 16 times more power than a PSK31 transmitter to achieve the same signal to noise ratio. Therefore, a PSK31 station can operate at 16 times less power than a CW station.

PSK creates a problem of key-clicks. The solution for eliminating key-clicks is to filter the output or to shape the envelope amplitude of each bit. The same problem of key-clicks may appear at the receiving end. PSK31 can eliminate this problem by filtering the receive signal or by shaping the envelope of the received bit. If a simple cosine wave is used at the receiver, a signal from one receive bit may be spread into the next bit. At the receive end, 4 bits are shaped at a time. The transmit and

receive filters must be matched to each other. Over-driving the audio can create intermodulation products if it is not linear. So, it is important to not over-drive the audio.

BPSK (Binary PSK) mode that does not have forward error correction but is probably the most common mode on the bands. It can be identified by its two vertical lines in the "Vector" signal view window.

QPSK (Quadrature PSK) is another mode whereby instead of phase reversals (180 degree phase shifts), and additional pair of 90 and 270 degree phase-shifts are possible. It is like having two PSK (BPSK) transmitter on the same frequency, but, 90 degrees out of phase with each other. The result is twice the bit rate and 3 db less signal-to-noise ratio. QPSK mode has forward error correction but is a little harder to tune. It can be identified by its two vertical lines and two horizontal lines in the "Vector" signal view window. It is also sideband sensitive. Sometimes lower sideband is used.

PSK uses a personal computer and a 16 bit computer sound card. The audio output from the sound card is connected to the audio input of the transceiver with a 100:1 voltage divider to reduce the voltage from the sound card audio output to the transceiver audio input. Some interfaces use transformer isolation and some use opto-isolation. There a number of radio sound card interfaces available commercially. Most include a microphone connector, wire with microphone plug, bypass switches, a computer RS232 connector, and audio inputs and outputs.

## Software

There are a number of software programs that can be used for PSK. This author used the highly recommended WinPSKse. It is freeware available at <http://www.psk31.com> along with various article and technical information on PSK31. WinPSKse is an adaptation of AE4JY's fine WinPSK program expertly crafted by Dave Knight, KA1DT. WinPSKse has the ability to display and read two PSK31 signals at the same time, in an easy to read and interpret presentation. This has a much improved user interface. For example, it has an amazing new simultaneous spectrum/waterfall display.

## Some PSK31 calling frequencies

BPSK primarily uses upper side band mode.

1,838.150 kHz

3,580.150 kHz to 3.620 kHz

7,035.150 kHz for region 1 and region 3, and 7080.15 for region 2 (the Americas)

10,142.150 kHz

**14,070.150 kHz (Primary calling frequency)**

18,100.150 kHz

21,080.150 kHz 150 (although most activity can be found 10 kHz lower)

24,920.150 kHz

28,120.150 kHz

145,550 kHz

## Receive Audio Input Level

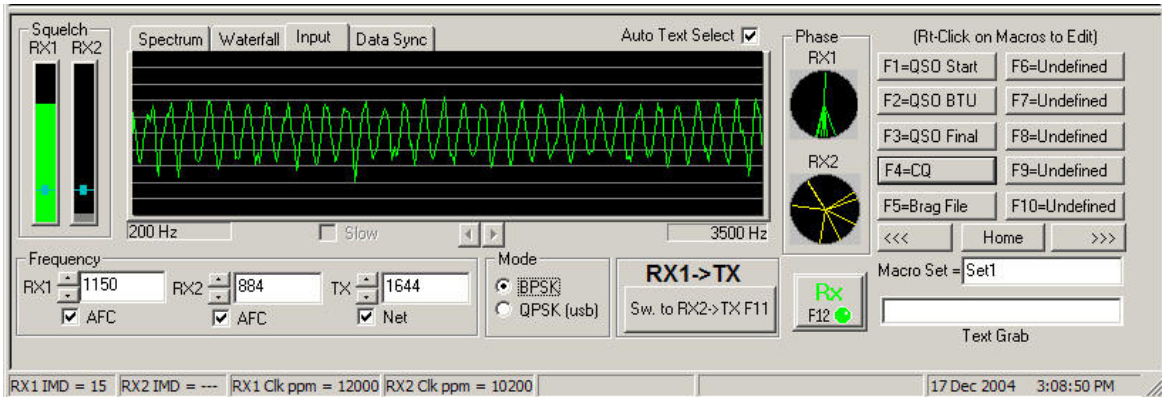

Tune the radio to a loud signal or carrier at 14,070.150 kHz. Display the soundcard's mixer program (or use the one that comes with Windows). Set the mixer's LINE IN setting to mid way. Adjust the volume control on the radio while viewing the INPUT signal display in the software program. The volume should be adjusted for a good signal level that is not too high and not too low.

## Tuning in a PSK31 Signal

In the spectrum display view, look for peaks. Click the mouse on a peak to change the receive frequency marker position. If the display is not showing anything, adjust the soundcard Recorder mixer volume control or the volume control of the radio. Below is a typical PSK31 signal (RX1).

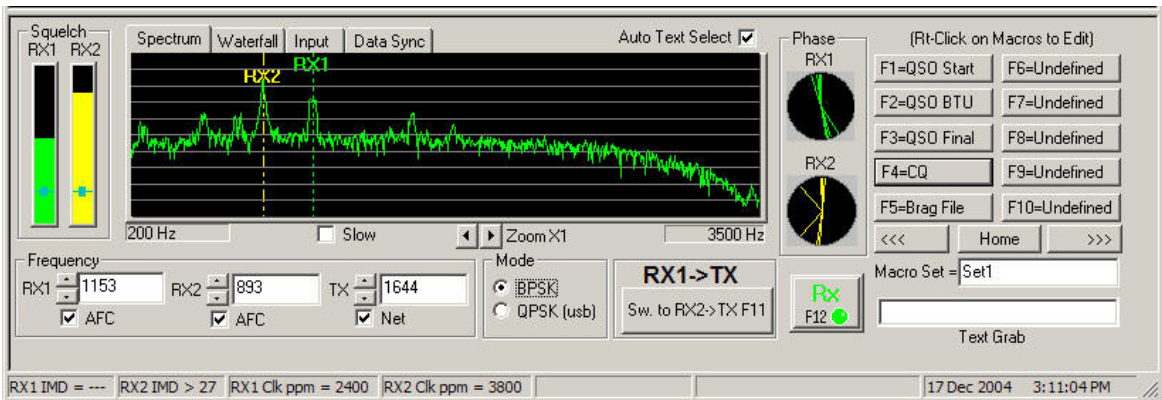

## Transmit Audio Level Adjustment

Transmit level is more complicated to adjust than the receive level because the actual signal spectrum coming out of the transmitter cannot be seen at the transmitter. Adjust the mixer's VOLUME setting to adjust the transmit audio level. The best method is to guess at a good level (mid way), then get a critical signal report over the air. The correct setting will vary from radio to radio. It is better to under-drive the radio until a clean signal is clean is obtained. In general never drive the transmitter anywhere near its rated power at first.

## Operation Hints and Tips

The actual Transmit/Receive frequency is the USB radio dial frequency plus the audio frequency displayed in software. If using LSB, subtract the audio frequency from the radio dial setting. For example if the transceiver is in the USB mode and reads 14070.00 KHz and the audio frequency is 1500 Hz, then the actual transmit/receive frequency is 14071.50 KHz.

The TX and RX frequencies are limited between 200 and 3500 Hz. It is best to avoid the edges because transmitters may have some frequency limitations as well as some soundcards.

Don't send all text as UPPER CASE letters. PSK31 was designed to send the most commonly used letters such as 'e' and 't' much faster than letters such as 'z' that are used less frequently. Uppercase letters take much longer to send and slow down the transmission. Capitalize letters as needed. A common practice is to send callsigns in upper case.

Make sure the PC time and date are set correctly.

Try using the QPSK mode when conditions get rough. In many circumstances, using QPSK will greatly improve reception due to its error correcting capability.

# Winlink 2000

## Normal Internet Connection



## Radio Communications During a Local Interrupted Internet Connection

### Interrupted Area



Short Distance (75 miles)

### Non-interrupted Area



## Radio Communications During a Regionally Interrupted Internet Connection

### Interrupted Area



Long Distance (hundreds to thousands of miles)

### Non-interrupted Area



Winlink 2000 is a worldwide digital amateur radio message transfer system. It provides E-mail transfer with attachments, map & text-based position reporting, graphic & text-based weather bulletin services, and emergency communications by linking radios to the Internet.

The Winlink 2000 system is currently being utilized for emergency communications where local or regional communications are disrupted, including the loss of the Internet, and where accuracy of information is important.

Winlink 2000 can be used by any licensed Amateur radio operator. The operator logs into one of the participating network stations using the "AirMail" software. Currently, Winlink 2000 has a flow of over 150,000 messages monthly into 41 participating stations from 5100 + users. The Winlink 2000 user must have a General Class or higher license to use HF radio.

Winlink 2000 may be very useful for emergency communications using the Telpac with Paclink email-based VHF/UHF radio Packet for "last mile" communications coverage. Airmail is used for greater distances using the HF radio link to Winlink 2000 and the internet.

"Telpac" stands for TELnet-PACket Bridge and it allows the Winlink 2000 operator to use the VHF/UHF Packet mode with the B2F protocol. Telpac is used by the Packet nodes to interface with the end-user, who is using Paclink or Airmail. Paclink utilizes Outlook or Outlook Express to provide the end-user with a connection to the Winlink 2000 system by way of Telpac.

PACTOR is an HF (3 to 30 MHz.) radio teletype mode developed in Germany by Ulrich Strate (DF4KV) and Hans-Peter Helfert (DL6MAA) to improve on inefficient modes such as AMTOR/SITOR and Packet-Radio (AX.25) in weak short wave conditions. PACTOR offers a much better error correction system, and a considerably higher data transfer rate, than AMTOR/SITOR and result in a protocol much more resistant to interference than Packet-Radio under poor propagation conditions. For the first time in amateur radio, online data compression is used to increase the effective transmission speed. Pactor I is capable of 200 bps. PACTOR II is capable of 800 bps. PACTOR III is capable of 3600 bps. To use PACTOR, a PACTOR TNC/Modem is used in place of a packet TNC and HF frequencies are used.

The dial (transmit) frequency is 1,500 KHz lower than the center frequency.

#### **Current PACTOR nodes in the United States:**

AB7AA - Bill in Waikiki Beach, Oahu, Hawaii, Scan Center Frequencies  
3641.9, 7103.7(P3), 10142.7(P3), 14064.4, 14109.2(P3), 18104.9, 18106.2(P3)

AH6QK - Richard in Kaneohe, Oahu, Hawaii, Scan Center Frequencies:  
7070.9, 10126.9, 14069.0, 14110(P3), 18101.9

KA6IQA - Tom in Rancho Santa Fe, California, Scan Center Frequencies:  
7066.9, 7101.2(P3), 14112.4, 14104.2(P3)  
18102.9, 18106.7(P3), (13:00 to 03:00 UTC)

KB6YNO, Hamilton, Massachusetts, Scan Center Frequencies:  
7069.9, 10125.9, 14067.9, 14094.9 (P3), 18098.9

KF6NPC - Mike in Riverside County, CA., Scan Center Frequencies:  
3621.2, 7067.9, 7103.7, (P3), 10146.2 (P3), 14096.0 (P3)  
VHF 1200 baud packet frequency for KF6NPC: 145.07

KN6KB - Rick in Rockledge, Florida, Scan Center Frequencies:  
7068.9, 7103.7(P3), 10146.2(P3), 14066.4

KQ4ET – Joel, Virginia Beach, VA, Scan Center Frequencies:  
3628.7, 7067.9, 10146.5(P3), 14110.0(P3)

K4CJX - Steve in Nashville, Tennessee, K4CJX Center Scan Frequencies:  
Station # 1: 7076.9 (P2), 7101.2 (P3), 14076.9 (P2), 14106.7(P3)  
Station # 2: 10123.9 (P2), 10141.2(P3)  
Station # 3: 18103.9 (P2), 18108.7(P3)

K4SET - Scott in Murray, Kentucky, Scan Center Frequencies:  
7074.9, 7103.7(P3), 10,136.9, 10143.4(P3), 21073.9, 21095.2 (P3)

K6CYC - Scott in Los Angeles, California, Scan Center Frequencies:  
7069.9, 10123.9, 10143.7# - Omni-directional  
21068.9, 21096.2(P3), 14068.9, 14102.7(P3) - Beaming South Pacific

W7IJ - Bill in Spanway, WA, Scan Center Frequencies:  
Station 1: 3631.9(P3), 7068.9(P2), 7103.7 (P3), 10139.5 (P2)  
Station 2: 14069.4(P2), 14110.0 (P3), 21077.9 (P2), 21091.2 (P2)

K6IXA - Grady in Atwater, California, Scan Center Frequencies:  
Station # 1: 10122.9, 10143.7(P3)  
Station # 2: 14064.9, 14102.7(P3)

K7AAE - Ronald in Woodinville, Washington, Scan Center Frequencies:  
Station # 1: 3629.9, 7076.9, 10133.9, 10145.7(P3)  
Station # 2: 14067.9, 14109.2(P3)

N8PGR, North Royalton, Ohio (20 miles south of downtown Cleveland and lake Erie)  
Scan Center Frequencies: 3621.9, 7071.9, 10140.4, 14117.9

NOIA - bud in Deltona, Florida, Scan Center Frequencies:  
3626.9, 7072.9, 10133.9, 14072.9, 14098.7(P3), 18106.2(P3)

WA2DXQ - Dave in Ft. Lauderdale, Florida

WB5KSD - Jon in Farmersville, Texas, Scan Center Frequencies:  
7075.9, 10132.9, 14078.9, 14109.2 (P3)

WB0TAX - Deni in Elm Grove, Louisiana, Scan Center Frequencies:  
7103.7 (P3), 10133.9, 10143.7 (P3), 14066.9 (P2), 14096.2 (P3), 18106.2 (P3)



WD8DHF - Gary in Harker Heights, Texas, Scan Center Frequencies:

Station #1: 3590.9, 7075.4, 70103.7(P3), 10,127.9

Station #2: 14075.4, 14098.7(P3), 18075.4, 18107.9(P3)

Station # 3: 21075.4, 21091.2 (P3)

WU3V - Jim in Great Falls, MT, Scan Center Frequencies:

3631.2 (ALL), 7074.9, 7103.7(P3), 10126.9, 10143.4(P3), 14069, 14102.7(P3)

WX4J - Earl in Switzerland, Florida, Scan Center Frequencies:

3622.4, 3620.9(P3), 7066.9, 7065.4(P3), 10143.4, 10141.9(P3) 14066.9, 14065.4(P3)

W1ON, Bedford, Massachusetts (near Boston), Scan Center Frequencies:

3620.9, 7070.9, 14075.9, 14104.2 (P3), 18100.9

W6IM - Rod in San Diego, California, Scan Center frequencies:

Dipole - 7073.9, 10141.2(P3)

Beam (135 deg) - 14073.9, 14098.7(P3)

W7BO - John in Woodland, Washington, Scan Center Frequencies:

7.067.9, 7101.2(P3)

W9GSS, East Peoria, Illinois, Scan Center Frequencies:

7072.9, 14073.9, 14109.9 (P3), 21098.0 (P3)

W9MR, Keensburg, Illinois, Scan Center Frequencies:

7065.9, 10145.2 (P3), 14069.9, 14101.7 (P3)

### Current PACTOR nodes in Canada:

VE6KBS - Karl in Calgary, Alberta, Center Scan Frequencies:

7096.0, 7096.5(P3), 14078.9, 14104.2(P3), 18100.9, 18106.2(P3), 21079.9, 21098.7(P3)

VE2AFQ - Andre in Montreal, VE2AFQ Scan Center Frequencies:

7073.9, 7101.4 #, 14068.9, 14109.9 #, Telpac: 145.070 MHz

VE1YZ - Neil near Halifax, Scan Center Frequencies:

7067.9, 10129.9, 10148.2(P3), 14111(P3), 14112.9

## **Airmail Software Protocols**

**Software:** Download and install "Airmail" version 3.1.936 or later.

### **Address Book Setup**

Main page  
Click on the black book icon (second from left)  
Click New  
Name: person's name  
To: Their email address  
Email gate: Email  
Post Via: WL2K  
Click OK

### **Formatting a New Message**

Main page  
Click on white page icon (third from left)  
Click on a name from your address book  
Click OK  
Type a message  
Click on the small floppy disk icon (6th from the left to save it)  
Click on the mailbox icon to post it (7th from the left to say it is ready to send)  
Now, click on the Outbox (on the left, you should see a mailbox with a blue arrow and the message) The message will be sent by whatever modality is used to make a connection.

### **Telnet Client Setup**

Internet connection to this computer is required  
Main page  
Click on Modules  
Click on Telnet Client  
Click on the yellow shaking hands  
Click on New  
Place in the boxes  
Remote Callsign: K4CJX  
Remote Host: k4cjx.no-ip.com  
Port: 12001  
Timeout: 30  
Local Callsign: your call  
Password: WL2KTELNETCLIENT  
Check B2  
Click OK  
You should see K4CJX in the window at the top of the Telnet Client now.  
Click the green button/icon and if you are connected to the Internet it should make a connection with Steve and sign off automatically.

### **Sending a Message Through Telnet**

Main page  
Click on modules  
Click on Telnet Client  
Click on the green button and the message should go. Watch closely, it does not take long.

### VHF Packet Client Setup

Main page

Tools

Options

Modules

VHF Packet Client - check the block and click on the Setup button

From the Connections column:

TNC Type: select the TNC you are using - KPC-3 is at the bottom of the list

Com Port: Select your computers serial com port (usually Com1)

Baud Rate: Select the serial port baud rate (usually 9600)

Do not make changes in the Port Settings column

Check Show Hints

Check Terminal Window and Telnet Client

Check Show in Taskbar for Terminal Window and for VHF Packet Client and Telnet Client

Click Apply at the bottom

Click OK

Close Airmail and restart it.

Note: you cannot program multiple connections. You need to connect directly with a Telpac node.

### Sending a Message Through VHF/UHF Packet

Main page

Click on modules

Click on Packet Client

Connect To: callsign of the Telpac Station

Connect As: your callsign

Click on the green button and the message should go. Watch closely, it does not take long.

### Sending a Message Through VHF/UHF Packet via Multiple Nodes

Main page

Click on modules

Click on Packet Client

Connect To: callsign of the first packet station

Connect As: your callsign

Click on the Handshaking icon (third from the left)

Click on the green button

Once connected to the first packet station, Click on the Keyboard Icon (fourth icon from the left)

Using the connect command (c) in the lower window (C callsign) to connect to the next node

If you need the connect to more nodes, use the above step repeatedly until you come to the Telpac node

Once connected to the telpac node, click on the Handshaking icon (third from the left)

The message should go. It may take a long time depending upon the number of nodes used

### HF Client Setup

Main page

Tools

Options

Connections

From the Modem (TNC) Connection column:

Modem type: select the modem you are using (PTC-Illex)

Com Port: select the com port you are using (usually Com1)

Baud Rate: Select the serial port baud rate (57600)

Center Frequency: 1500

Check USB

From the Modem (TNC) Connection column:

Select none if you do not have a remote control for your radio

Check Show Hints

Click Apply at the bottom

Click OK

Close Airmail and restart it.

### Sending a Message Through HF

Main page

Click on modules

Click on HF Client

Connect To: callsign of the PMBO Station

Connect As: your callsign

Click on the green button and the message should go. Watch closely, it does not take long.

Note: the first you log onto an HF station, your callsign and license may need to be verified.

# Satellite Radio



Amateur Satellite Radio (AMSAT) is basically a repeater or transponder in orbit around the earth. There are several satellites in Low Earth Orbit and several satellites in High Earth Orbit.

There are four basic categories of satellites:

1. Low Earth Orbit – Analog (CW and Voice)
2. Low Earth Orbit - Digital
3. High Earth Orbit
4. Occupied Spacecraft

Most of the amateur satellites and occupied spacecraft are in Low Earth Orbit (LEO). Low Earth Orbit satellites orbit the earth many times a day. Because Low Earth Orbit satellites have low orbits, and sensitive receivers, omni directional antennas can be used without substantial amounts of power. However, their passes are short and communications must consequently be short. Low Earth Orbit satellites typically have an approximate 90 to 100 minute period of evolution (time to make one orbit around the earth). Your communications window is approximately 8-20 minutes. Low Earth Orbit satellites typically have orbits of approximately 250 km to 1,000 km. The orbits of occupied spacecraft are typically below 500 km.

High Earth Orbit (HEO) satellites require beam antennas, azimuth/elevation rotators, computer tracking, and higher power radios. High Earth Orbit satellites will have longer passes and consequently longer communications capabilities. High Earth Orbit satellites typically have orbits of approximately 11 hours. High Earth Orbit satellites typically have orbits of 35,000 km at apogee and 4,000 km at perigee.

There are currently several analog satellites including RS-12, UO-14, RS-15, FO-20, AO-27, FO-29, SO-41, and the occupied spacecraft in orbit. The equipment required to communicate with these satellites are: an HF radio and/or a 2m / 70 cm radio. Packet equipment is required for digital work. Receiver preamps may also be needed.

Sending a transmission to a satellite is called an "uplink." Receiving a transmission from a satellite is called a "downlink." Uplink and downlink frequencies are different. Oscar is an acronym for "Orbiting Satellite Carrying Amateur Radio."

Working a satellite is very similar to working "split" on HF or "cross-band" repeat on repeaters, where you transmit on one band and listen on another. For example, if you chose RS-12, it will accept a signal anywhere from 145.910 MHz to 145.950 MHz and retransmit between 29.410 MHz and 29.450 MHz. These are known as the uplink and downlink passbands, and there is a direct relationship between them. A signal you transmit at 145.920 MHz will be retransmitted by the satellite at about 29.420 MHz and 145.930 MHz comes down as about 29.430 MHz, etc. This is because RS-12 (as well as RS-15) uses what is known as a "non-inverting linear transponder". The international space station uses uplink and downlink in the same (2 meter) band.

The following is a list of common satellite modes:

Dual Band Modes

A	2 meters uplink	10 meters downlink
B (UV)	70 cm uplink	2 meters downlink
J (VU)	2 meters uplink	70 cm downlink
K	15 meters uplink	10 meters downlink
LU	23 cm (1.2 GHz) uplink	70 cm downlink
LV	23 cm (1.2 GHz) uplink	2 meters downlink
US	70 cm uplink	13 cm (2.4 GHz) downlink
LS	23 cm uplink	13 cm downlink
T	15 meters uplink	2 meters downlink

Single Band Modes

V	2 meters	2 meters
U	70 cm	70 cm
L	23 cm	23 cm
S	13 cm	13 cm
X	3 cm	3 cm

Uplink indicates the earth station transmit frequency. Downlink indicates the earth station received frequency.

Some satellites have dual modes that operate simultaneously. Satellites have 3 basic types of retransmissions: beacon, transponder, and repeater. Most satellites have a fixed Morse code beacon at the lower end of the satellites band-pass transponder. This is useful to detect when the satellite has crossed the horizon and is in range for operation. It can also be used to determine doppler shifts.

A transponder is similar to a repeater, but has a range of frequencies that are converted from one band to another. This range of frequencies is known as the pass band of the transponder. There are two types of transponders: Non-inverting and inverting. A non-inverting transponder will receive an upper side band signal at the high end of the uplink pass band and it will transmit it as an upper side band signal at the high end of the downlink pass band. An inverting transponder will receive an upper side band signal at the high end of the uplink pass band and it will transmit it as a lower side band signal at the lower end of the downlink pass band.

A repeater closely resembles an earthbound repeater. It listens for signals on one frequency and transmits on another frequency. All satellite repeaters (and transponders) are full duplex, meaning one can listen to the signal on the downlink while transmitting. Headphones are often used to avoid audio feedback.

Unlike earthbound communications where it is possible to pick a frequency and stay there, there is a phenomenon known as Doppler Shift that satellite that must considered. An example of Doppler shift is hearing a train blowing its whistle as it passed by? The tone changes as the train comes close and moves away. The sound inside the train remains the same. The change in tone is a result of the Doppler Shift. Signals coming from space experience the same phenomena as the satellite moves at a speed of about 17,000 miles per hour. The operator has to constantly tune the receiver and transmitter to make up the difference. The frequency shift varies by band. On RS-12 with its 2 meters uplink and 10 meters downlink, the change is about +/- 2.5 kHz. On FO-20 and FO-29, where the uplink is 2 meters and the downlink is 70 cm, the shift is about +/- 10 kHz.

Satellites travel in an elliptical orbit. Apogee is the point in a satellite's orbit where it is farthest from the earth. Perigee is the point in a satellite's orbit where it is closest to the earth. Inclination is the angle of the orbital plane with respect to the earth's equator. A node is the point where the orbital path crosses the equator. The ascending and descending pass is the south to north or north to south communications opportunity. These are also the points of Acquisition of Signal (AOS) and Loss of Signal (LOS). A footprint is the area of the earth's surface, which is visible to the satellite at one time. The lower the satellite's orbit, the smaller the footprint. Keplerian Elements (KEPS) are a set of numerical data that represents a satellite's orbital characteristics. The use of this information allows tracking programs to determine where that satellite is at any one time, to predict passes, and plot ground tracks. Keplerian elements should be updated every few weeks for stable orbits and more frequently if the object's orbit is altered. The AMSAT format is the most user-friendly format of Keplerian elements. However, the NORAD Two-Line Element (TLE) is the indigenous format available from NASA.

The AMSAT format looks like this:

```
Satellite: AO-27
Catalog number: 22825
Epoch time: 03177.89093483
Element set: 590
Inclination: 98.2597 deg
RA of node: 200.9638 deg
Eccentricity: 0.0007455
Arg of perigee: 236.0777 deg
Mean anomaly: 123.9698 deg
Mean motion: 14.28984247 rev/day
Decay rate: 4.2e-07 rev/day ^ 2
Epoch rev: 50820
Checksum: 344
```

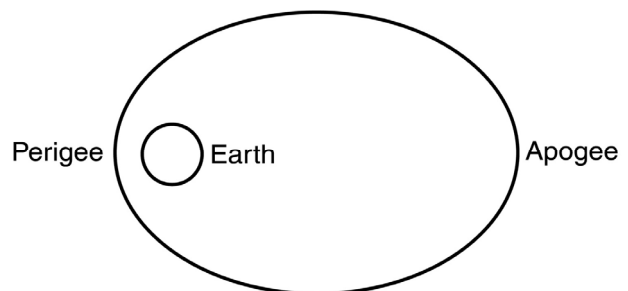

Some communication satellites stay stationary with respect to the earth so that TV signals can be received with small antennas. To achieve this stationary position, a satellite must have a one-day orbital period like earth. The satellite to earth distance is calculated as 35,768 km. The satellite orbit must be circular with near zero inclination to stay stationary. If the orbit is closer to an inclined ellipse, the satellite

projection to the earth surface will follow a skewed figure 8 pattern. This pattern is good for amateur radio because it can cover additional surface area of the earth and the satellite is closer to the earth at perigee.

Most of the time satellites are no higher than 35 degrees or so above the horizon. The closer the satellite is to the horizon, the greater the distance it is from the observer and the higher the path loss and the greater the transmit and receive gain that is needed. Vertical antennas will work well, especially ones with some gain, although some of the really high gain verticals are optimized for low angles of radiation and the signal strength falls off rapidly as the elevation angle increases. Another problem with verticals is that noise tends to be vertically polarized. This is not a problem with FM signals, but a big problem with SSB and CW. Dipole antennas also work well, but they often suffer a loss of gain off the ends. Beam antennas can be tilted up about 30 degrees to provide more gain toward the horizon. However, many satellite operators report excellent results in the standard flat horizontal orientation. When using beam antennas, the operator will need to continuously correct their direction as the satellite moves by. This becomes difficult to manage manually with the low earth orbit satellites because they have relatively fast velocities. Computer controlled antennas with azimuth/elevation rotators can track the satellites with ease. Azimuth/elevation rotators and computer controllers tend to be expensive.

A radio signal passing through the ionosphere changes polarization. A horizontally polarized signal transmitted from a satellite would change polarization when reaching earth. This phenomenon is called the Faraday Rotation. Circularly polarizing antennas are often used to deal with Faraday Rotation. Circularly polarized antennas will also minimize the spin modulation effect, which is caused by a satellites rotation of approximately 1 revolution per second.

Most satellites have an automatic transmitter at the satellite called the beacon. The beacon is usually located at the high or low end of the pass-band and will send out satellite identification and telemetry. Most beacons use CW.

When beginning satellite operation, try to get on one of the FM satellites, such as UO-14, AO-27, or ISS. These satellites are probably the easiest to work with a minimum amount of equipment. This can be done with an HT and a directional antenna. The antenna does not need to have much gain. It can be a 3-element beam that is held pointing at the satellite. Arrow antenna makes the 146/437-10 handheld antenna with a foam grip for about \$75. Satellites like FO-20 and FO-29 are easy to work, but require two beams with an azimuth/elevation rotator and a computer controller. More sophisticated equipment will allow you to transmit and receive simultaneously on 2 bands and make frequency shifting for Doppler correction easier. At the time of this writing, AO-27 is only available on weekends. UO-14 is probably the best satellite to start with. ISS is easy to reach since it is so low. However, the ISS crew are not always available. Check the NASA website site for "Crew Scheduling" to see what times are allocated for amateur radio.

There are a number of tracking software programs on the market. After much trial and error by this author, the NOVA software program appears to be the best. It works well with Windows XP and the operator can update the Keplerian elements with the click of the mouse, provided there is with an internet connection. Some programs were actually inaccurate as compared to the online tracking by NASA of the international space station.



Online resources include:

<http://www.amsat.org>

<http://www.amsat.org/amsat/news/wsr.html> (weekly satellite status report)

<http://www.amsat.org/amsat/ftp/keps/current/amsat.all> (Keplerian elements)

<http://www.arrl.org>

<http://ariss.gsfc.nasa.gov>

<http://spaceflight.nasa.gov/realdata/tracking/index.html> (tracking international space station)

<http://www.nlsa.com/index.html> (Nova satellite tracking software)

<http://www.orbitessera.com/> (N2WWD webpage)

**Kilometer** = Miles x 1.621388

**Miles** = Kilometers x 0.621388

**Region 1:** Africa, Europe, Russia, Middle East (excluding Iran), and Mongolia

**Region 2:** The Americas, including Hawaii, Johnston Island, and Midway Island

**Region 3:** The rest of Asia and Oceania

## Low Earth Orbit – Analog Satellites (partial list)

<u>Satellite</u>	<u>Frequencies (MHz)</u>	<u>Transponder /Beacon</u>	<u>Mode</u>	<u>Notes</u>
<u>RS-15 (NORAD 23439)</u>				
Launched: December 26, 1994 from the Baikonur Cosmodrome				
Approximate height (varies) 2,160 km – 1,885 km				
Downlinks	29.352	B		CW
	29.354 - 29.394	T	A	CW / USB
Uplinks	145.858 -145.898	T	A	CW / USB
Semi-operational as of June 8, 2003				
<u>FO-20 (Fuji-OSCAR 20, NORAD 20480) (2)</u>				
Launched: February 07, 1990 by an H1 launcher from the Tanegashima Space Center in Japan.				
Approximate height (varies) 1,745 km – 912 km				
Downlinks	435.795	B		CW
	435.800 - 435.900	T	J	CW / USB
Uplinks	145.900 - 146.000	T	J	CW / LSB
Operational as of June 8, 2003				
<u>AO-27 (OSCAR 27, AMRAD, NORAD 22825) (3)</u>				
Launched: September 26, 1993 by an Ariane launcher from Kourou,				
Approximate height (varies) 804 km – 790 km				
Downlink	436.795		J	FM Voice
Uplink	145.850		J	FM Voice
Semi-operational as of June 8, 2003				
<u>FO-29 (Fuji-OSCAR 29, NORAD 24278) (also see 1200 and 9600 Baud)</u>				
Launched: August 17, 1996, by an H-2 launcher from the Tanegashima Space Center in Japan.				
Approximate height (varies) 1,333 km – 801 km				
Downlinks	435.795	B		CW
	435.800 - 435.900	T	J	CW / USB
Uplinks	145.900 - 146.000	T	J	CW / LSB
Downlink	435.910	B		FM Voice digitalker
Downlink	435.795	B		12 WPM CW telemetry
Operational as of June 8, 2003				
<u>SO-41 (SAUDISAT 1A, NORAD 26545)</u>				
Launched: September 26, 2000 aboard Soviet ballistic missile from the Baikonur Cosmodrome.				
Approximate height (varies) 672 km – 614 km				
Downlink	436.775		J	FM Voice
Uplink	145.850		J	FM Voice
Operational, but, intermittent as of June 8, 2003				

SO-50 SAUDISAT-1C

Launched: December 20, 2002 aboard a Soviet ballistic missile from the Baikonur Cosmodrome.

Approximate height (varies) 650 km

Uplink 145.850 MHz (67.0 Hz PL tone) T J FM Voice

Downlink 436.800 MHz T J FM Voice

Operational as of June 8, 2003

AO-51 (ECHO)

Launched: July 30, 2004

Approximate height (varies) 718 km

Analog Uplink 145.920 MHz FM (PL - 67Hz), 1268.700 MHz FM (PL - 67Hz)

Analog Downlink 435.300 MHz FM, 2401.200 MHz FM

PSK-31 Uplink 28.140 MHz USB

Digital Uplink 145.860 MHz 9600 bps, AX.25, 1268.700 MHz 9600 bps AX.25

Digital Downlink 435.150 MHz 9600 bps, AX.25, 2401.200 MHz 38,400 bps, AX.25

Broadcast Callsign: PACB-11

BBS Callsign: PACB-12

Operational as of November 10, 2004

**Low Earth Digital Satellites (partial list)**

<u>Satellite</u>	<u>Frequencies (MHz)</u>	<u>Transponder /Beacon</u>	<u>Mode</u>	<u>Notes</u>
<u>AO-16 (OSCAR 16, Pacsat, Microsat-A, NORAD 20439)</u>				
Approximate height (varies) 797 km – 780 km				
Downlinks	437.025	T/B	J	1200 bps PSK SSB
	437.051	T	J	1200 bps PSK SSB
	2401.14280	B		1200 bps PSK SSB - (usually off)
Uplinks	145.900	T	J	1200 bps AFSK FM
	145.920	T	J	1200 bps AFSK FM
	145.940	T	J	1200 bps AFSK FM
	145.960	T	J	1200 bps AFSK FM
Semi-operational as of June 8, 2003				
<u>NO-44 (PC-SAT, NORAD 26931)</u>				
Approximate height (varies) 800 km – 790 km				
Downlink	144.390		V	APRS
Uplink	145.827		V	1200 bps AX.25 AFSK
Operational as of June 8, 2003				
<u>FO-29 (Fuji-OSCAR 29, NORAD 24278) (see also Analog and 1200 Baud)</u>				
Approximate height (varies) 1,333 km – 801 km				
Downlink	435.910	T	J	9600 bps FM BPSK
Uplink	145.850	T	J	9600 bps FM
	145.870	T	J	9600 bps FM
	145.910	T	J	9600 bps FM
Callsign 8J1JCS, Operational as of June 8, 2003				

AO-51 (ECHO)

Approximate height (varies) 718 km  
 PSK-31 Uplink 28.140 MHz USB  
 Digital Uplink 145.860 MHz 9600 bps, AX.25, 1268.700 MHz 9600 bps AX.25  
 Digital Downlink 435.150 MHz 9600 bps, AX.25, 2401.200 MHz 38,400 bps, AX.25  
 Broadcast Callsign: PACB-11  
 BBS Callsign: PACB-12  
 Operational as of November 10, 2004

**High Earth Orbit Satellites (partial list)**

<u>Satellite</u>	<u>Frequencies (MHz)</u>	<u>Transponder /Beacon</u>	<u>Mode</u>	<u>Notes</u>
------------------	--------------------------	--------------------------------	-------------	--------------

AO-10 (OSCAR 10, Phase 3B, NORAD 14129)

Launched: June 16, 1983 by an Ariane launcher from Kourou, French Guiana.  
 Approximate height (varies) 35,421 km – 4,026 km

Downlinks	145.810	B		CW
	145.825 - 145.975	T	B	CW / USB
Uplinks	435.030 - 435.180	T	B	CW / LSB

Semi-operational as of June 8, 2003

**Occupied Spacecraft (partial list)**

<u>Satellite</u>	<u>Frequencies (MHz)</u>	<u>Transponder /Beacon</u>	<u>Mode</u>	<u>Notes</u>
------------------	--------------------------	--------------------------------	-------------	--------------

ISS (International Space Station)(NORAD 25544)(6)

ARISS (Amateur Radio on the International Space Station)(NORAD 25544)(6)

The ARISS initial station was launched September 2000 aboard shuttle Atlantis.  
 Approximate height (varies) 402 km – 391 km

Downlink	145.800	T	V	Worldwide voice/packet
Uplink	144.490	T	V	Region 2 & 3 voice
Uplink	145.200	T	V	Region 1 voice
Uplink	145.490	T	V	Worldwide packet

TNC callsign: RSOISS-1  
 U.S. callsign: NA1SS  
 Russian callsigns: RSOISS,  
 RZ3DZR

Operational as of June 8, 2003

# Antennas and Propagation

Any conducting material can act as an antenna. Designers go to “great lengths” to design antennas in order to control their radiation pattern and gain. The two main factors in antenna design and operation are the geometry of the antenna and the proximity of the antenna to nearby objects.

## The Half Wave Dipole

Each half of the half wave dipole is 1/4 wavelength. Together they make up 1/2 wavelength.

The free space wavelength of an electromagnetic wave is:  $L = c / f$  (Hz), where  $c = 300,000,000$  meters/second (velocity of light) or  $L$  (meters) =  $300 / f$  (MHz).

The velocity of a wave along an antenna or transmission is slower than it is in free space, usually about 95 % of  $c$ . Therefore, a half wave dipole is 5 % shorter than it's free space wavelength.

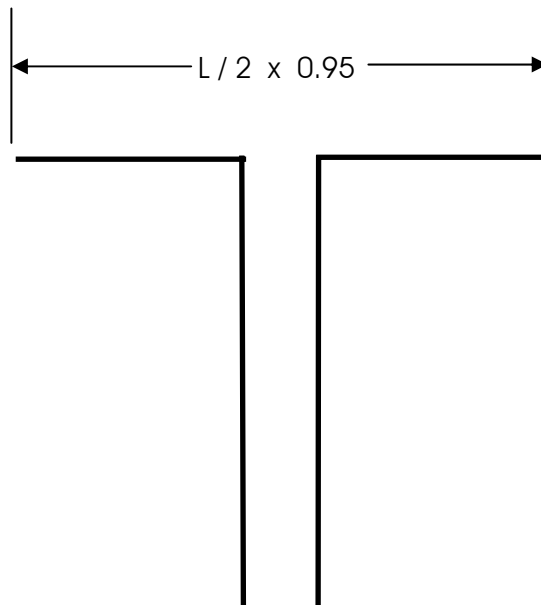

A 7 MHz. half wave dipole length =  $(c / f) \times 0.95 \times 0.5$  meters

A 7 MHz. half wave dipole length =  $(300 / 7) \times 0.95 \times 0.5 = 20.36$  meters

A 7 MHz. half wave dipole length =  $((c / f) \times 0.95 \times 0.5) \times 3.2808$  feet

A 7 MHz. half wave dipole length =  $((300 / 7) \times 0.95 \times 0.5) \times 3.2808 = 66.79$  feet

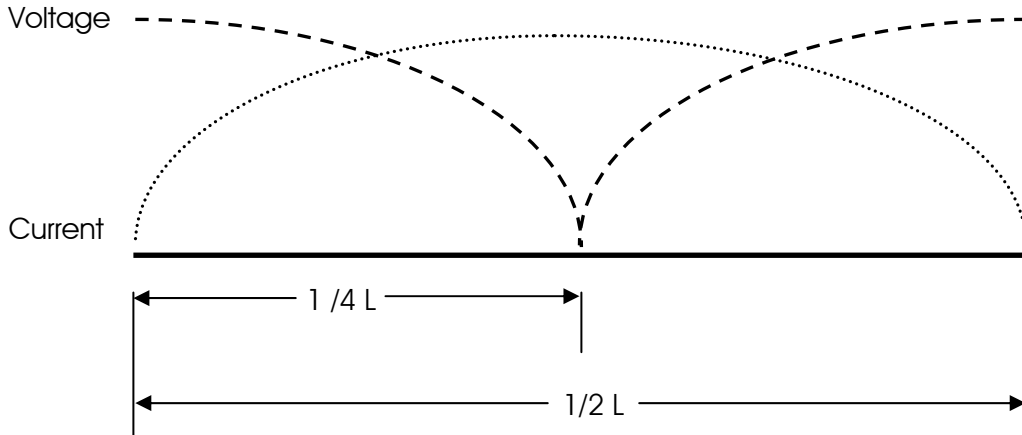

The voltage and current waves of an antenna are 90 degrees out of phase with each other.

If the current is high and the voltage is low, the impedance will be low ( $R = E/I$ ). The impedance is the lowest at the center of a half wave dipole (72 ohms). At the ends, the impedance is the highest (2,000-3,000 ohms).

The half wave dipole is resonant when the length is made such that the mid point yields the lowest voltage and highest current.

A  $1/4$  wavelength antenna or an antenna of multiple  $1/4$  wavelengths is a resonant antenna.

Any circuit is resonant when the inductive reactance and capacitive reactance are equal. At resonance, inductive reactance and capacitive reactance are 180 degrees apart and when equal, cancel each other, leaving only the resistance component. The shortest length of wire that can be resonant is a quarter wavelength.

If the antenna is shorter than a quarter wavelength, it will have a capacitive reactance. It will require the addition of an inductive reactance (loading coil) to cancel the capacitive reactance and become resonant.

If the antenna is longer than a quarter wavelength and shorter than a half wavelength, it will have an inductive reactance. It will require the addition of a capacitive reactance (capacitor) to cancel the inductive reactance and become resonant.

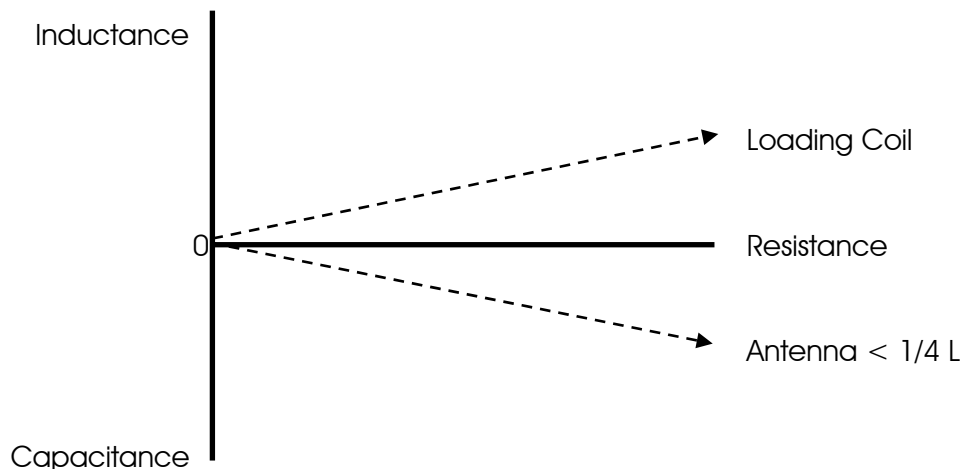

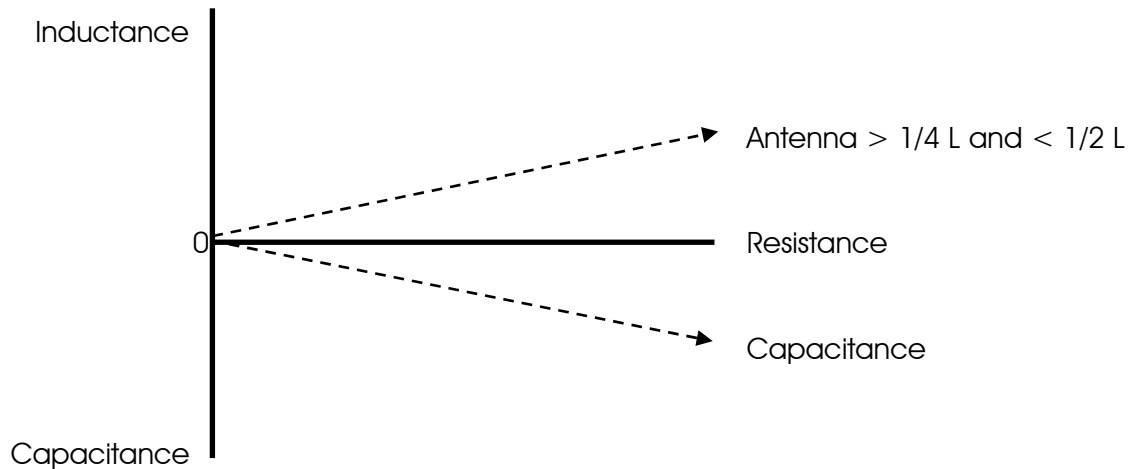

## The Five-Eighth Wave Ground Plane Antenna

Normally, a  $5/8 L$  antenna cannot be resonant because it is not a multiple of a  $1/4 L$ . However they are commonly found as vertical antennas. The vertical section is  $5/8 L$ , which has a capacitive reactance because it is longer than two  $1/4 L$ 's. An inductive loading coil is added somewhere along the length of the vertical to cancel the capacitive reactance. The  $5/8$  wave antenna is actually tuned to  $3/4 L$  by the addition of the loading coil making it effectively a  $3/4$  wavelength antenna. The four horizontal radials are  $1/4$  wavelength each.

## The Quarter Wave Ground Plane Antenna

The quarter wave ground plane antenna is often used with radials or installed on a flat conducting surface, such as the roof of a car. It is simply a reflector whereby some of the radiation will be reflected by the ground plan and interact with the incident wave from the antenna. This kind of antenna provides an omni directional pattern.

## The Yagi Antenna

A Yagi antenna has one driven element, a dipole, and at least one other parasitic element. The parasitic dipoles receive radiation from the main dipole and re-radiate it. The energy is radiated from the main driven element and after a short delay, energy is picked up and re-radiated by the parasitic elements. The antenna can be made to radiate in one direction by controlling the spacing and length of the parasitic elements to yield a greater gain.

The three element Yagi has: a driven element, a reflector element, and a director element. The primary direction of radiation is in the direction of the driven element to director element. The driven element length is determined by equations used to calculate the dipole antenna. The reflector is 5% longer than the driven element and the director is 5% shorter than the driven element. The spacing between the elements are usually between 0.15 to 0.2 wavelengths (0.18 for maximum forward gain).

Propagation delays caused by the spacing of the elements, causes wave cancellation towards the rear of the antenna and wave reinforcement towards the front of the antenna. The gain is usually about 6-8.5 dB over a dipole.

Additional elements can be added to a Yagi to increase the power gain. Additional elements are always directors placed in front of the driven element. Doubling the number of directors, will increase the gain by about 3 dB. Adding parasitic elements to a Yagi decreases the antenna bandwidth.

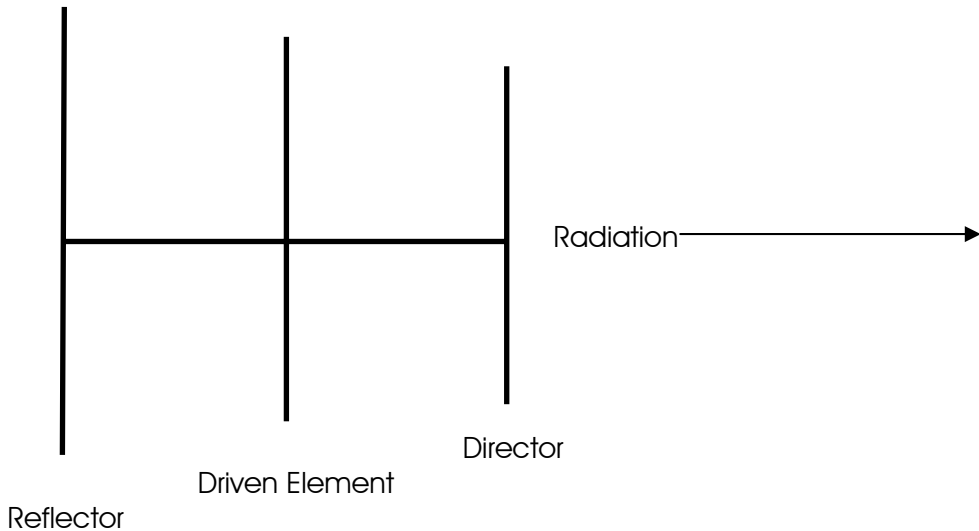

### The Folded Dipole Antenna

The folded dipole antenna is an antenna that consists of two dipoles connected in parallel. Folding the dipole increases the feed point impedance. Two dipoles folded, the feed point resistance increases by 2 squared (4), which is equal to 300 ohms. Three parallel dipoles increases by 2 cubed (8). The dipole forming the driven element of a Yagi antenna is often folded to increase the feed point impedance by 4.

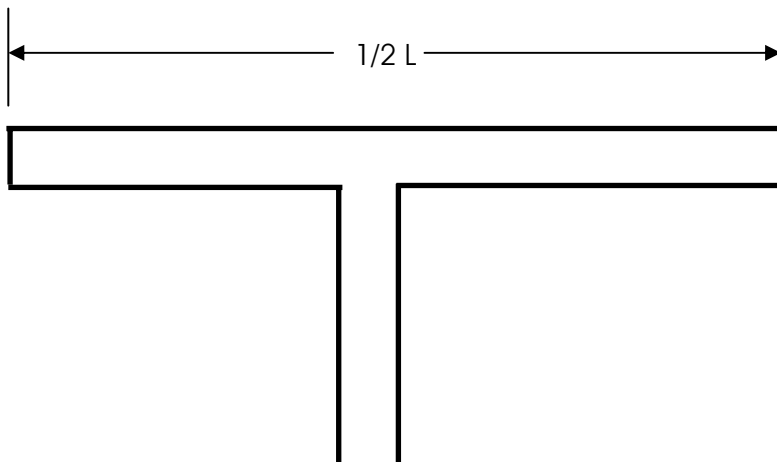



## Trapped Antennas

Traps are parallel tuned circuits used on HF antennas that have high impedances used to switch different sections of the antenna in and out of resonance. When the traps are not used at their resonant frequencies, they become loading coils and shorten the effective length of the antenna wire needed.

## Isotropic and Practical Antennas

The isotropic antenna is a theoretical antenna that radiates equally in all directions and serves as a reference. A half wave dipole antenna has a gain of 2.14 dB above an isotropic antenna. Rubber duck antennas have a loss of several dB below an isotropic antenna.

An antenna that directs most of the electromagnetic radiation in one direction has a power advantage over an omni directional antenna. The power gain of an antenna is the ratio of the power radiated in its primary direction as compared to the isotropic antenna. A gain of 6 dB is a factor of 4 and 1 "S" point on the S-meter.

The area of a dipole's radiation pattern (A1) is 1.64 times that of the isotropic's pattern (A2). Therefore, the gain can be calculated as  $\text{Gain} = 10 \text{ Log } (A1/A2) = 10 \text{ Log } (1.64/1) = 2.15 \text{ dB}$

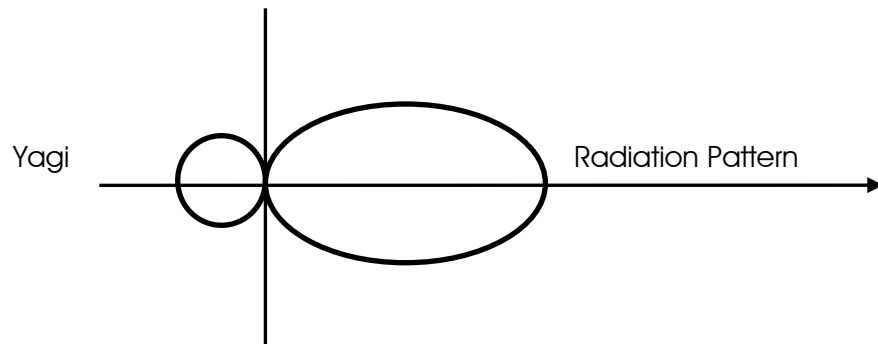
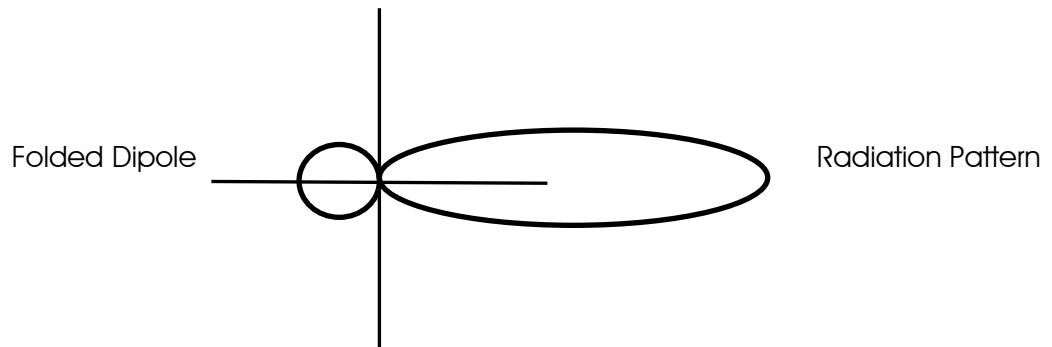
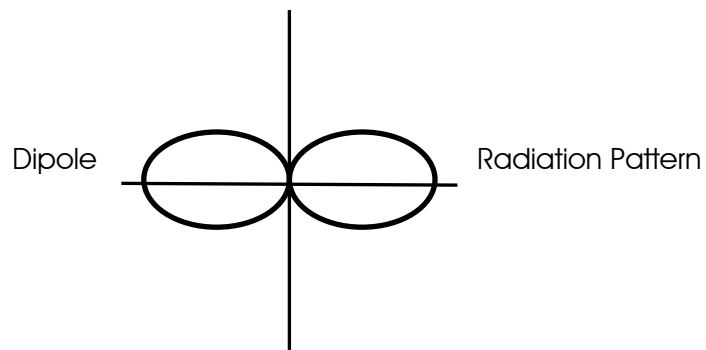
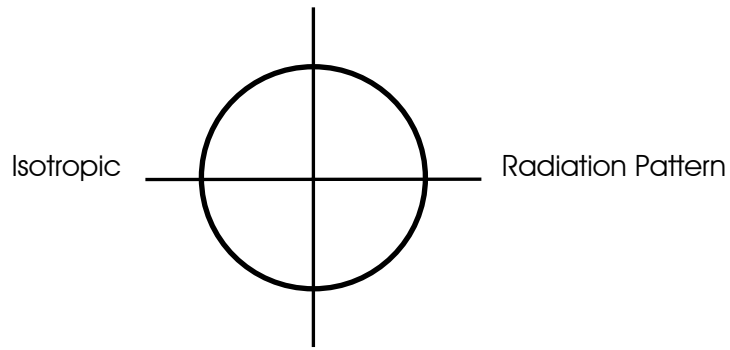

## Voltage Standing Wave Ratio (VSWR)

The Voltage Standing Wave Ratio (VSWR) is the ratio between the impedances of the feed line and the load. If we connect a 50 Ohm resistor at one end of a piece of 50 Ohm coaxial cable, and connect a transmitter and SWR meter at the other end, the VSWR will be 1:1. The resistor is not resonant. However, if we connect a resonant antenna that has an impedance of 144 Ohms to the end of that piece of cable, the VSWR will be 2.88:1 ( $VSWR = \text{Antenna Impedance} / \text{Feed Line Impedance}$ ).

If a feed line is cut to a length that creates a VSWR measurement of 1:1 at the transmitter end of that feed line, the actual VSWR on this line is (infinity):1. Using VSWR is not the best method for tuning an antenna. The best method to measure the resonant frequency of an antenna is to use an antenna bridge at the antenna.

High VSWR does not cause feed line radiation. Most of the radiation from a coaxial cable is caused by terminating an unbalanced feed line with a balanced load. The remainder of the radiation is due to other problems such as, braid corrosion, improperly installed connectors, and signal pickup caused by routing the feed line too close to, and parallel to the antenna.

A properly terminated and installed open wire line does not radiate. Even with infinite SWR, the fields surrounding each wire cancel each other out. Terminating the line in an unbalanced load, or causing anything to come within the "field space" will cause unbalance in the line, thus allowing the line to radiate.

## Propagation

The ionosphere is a layer in the Earth's atmosphere that lies in a range of 80 to 300 miles above the Earth's surface that reflects radio waves. As the sun shines on the ionosphere it changes composition and height, which affects the propagation characteristics. In general signals below 30 MHz bounce off this layer and return to Earth while signals above 30 MHz go through the layer into outer space. Radio signals that are bounced or refracted off the ionosphere are also affected by the time of day and season of the year.

During the 24-hour cycle the ionosphere changes in height above the Earth and bounces some signals while absorbing others. During the day the higher frequencies (above 10 MHz) tend to propagate while lower frequencies are absorbed. At night the reverse happens. There are many exceptions to this but it is a good general guideline.

Seasons also affect propagation. Summertime in the northern hemisphere means that higher frequencies have better propagation while in the winter the lower frequencies improve. An interesting time of the year for propagation is when the seasons change from fall to winter and from winter to spring. This is often when the best DX can be found. Because the seasonal change is occurring in both hemispheres but in the opposite direction DX from North American to Australia or southern Africa can be at its best.

Another phenomenon that affects radio propagation is the 11-year sunspot cycle. A peak occurred during the year 2000 and the next peak will occur around 2011. A sunspot low occurs at the midpoint of this cycle. When the sunspots are at their maximum propagation is at its best. At this time the higher shortwave frequencies exhibit the best propagation extending to 6 meters, which becomes quite popular during this time of the cycle. 10 meters can easily work stations worldwide with low power (even qrp) and a modest antenna.

<u>Band (meters)</u>	<u>Frequency (MHz)</u>	<u>Use (band conditions vary for many reasons)</u>
160	1.8 – 2.0	Night
80	3.5 – 4.0	Night and Local Day
40	7.0 – 7.3	Night and Local Day
30	10.1 – 10.15	CW and Digital
20	14.0 – 14.350	World-wide Day and Night
17	18.068 – 18.168	World-wide Day and Night
15	21.0 – 21.450	Primarily Daytime
12	24.890 24.990	Daytime During Sunspot Highs
10	28.0 – 29.7	Daytime During Sunspot Highs
6	50 – 54	Local to World-wide
2	144 – 148	Local and Medium Distance
70 cm	430 – 440	Local

## Near Vertical Incidence Sky wave Antennas

NVIS propagation is a propagation pattern that uses antennas with high-angle radiation (almost 90 degrees, vertical) and low operating frequencies for a range of about 0-300 miles.

Long distance propagation uses radio waves that are reflected from the ionosphere and return to earth at some distance away. Radio waves that are radiated at a very low angle, travel a long distance to reach the ionosphere at a very shallow angle and return to earth far away. When the angle of radiation increases, the radio waves reach the ionosphere at a greater angle, and return to earth closer to their point of origin. Signals that reach the ionosphere at a higher angle of incidence will not be reflected at all, but will continue out into space. The area of reflection that would have occurred is the "skip zone". Depending on operating frequencies, antennas, and propagation conditions, this skip zone can start at roughly 12 to 18 miles and extend out to several hundred miles, preventing communications.

NVIS antennas are designed to minimize the ground wave (low takeoff angle) radiation and maximize the sky wave (very high takeoff angle, 60-90 degrees). Essentially, the NVIS antenna radiates a wave almost straight up, then bounces from the ionosphere and returns to the Earth in a circular pattern around the transmitter. Because of the near-vertical radiation angle, there is no skip zone. Communications are continuous out to several hundred miles from the transmitter. The nearly vertical angle of radiation requires the use of lower frequencies, usually 2-10 MHz. This type of propagation is excellent when communicating over hills and mountains. These frequencies are the same frequencies that contain a lot of atmospheric noise, such as distant thunderstorms. The NVIS antenna is optimized for listening to signals from nearby areas, and minimizes the reception of signals from distant sources.

One of the most effective antennas for NVIS is a dipole that is mounted from 0.1 to 0.25 wavelengths above ground. When a dipole is brought very close to ground, the angle of radiation increases. In the range of 0.1 to 0.25 wavelengths above ground, vertical and nearly vertical radiation reaches a maximum. A dipole can be used at even lower heights, resulting in some loss of vertical

gain, but often, a more substantial reduction in noise and interference from distant regions. Heights of 5 to 10 feet above ground are not unusual for NVIS operation.

During a test by WOIPL, they used a 75-meter dipole at a height of 30 feet. They found the communications to be difficult. They set up a second dipole at a height of 8 feet. The background noise went from S7 to S3 and the communications with stations 25 miles and further, greatly improved. Many people find the 10 to 15 foot height to be ideal. Field tests have proven that the maximum NVIS efficiency is obtained at the 10 to 15 foot height for frequencies in the 40 meter to 75 meter range.

## Skip Zones

A skip zone is the area that is not covered by sky wave radiation. In other words, the sky wave angle is such that the sky wave travels a long distance before reaching earth. The distance between the transmitting antenna and the point where the sky wave reaches the earth is the skip zone.

The "take-off angle" is the angle at which a wave leaves the transmitting antenna.

Nomograph for determining primary skip zone (one hop) as a function of radiation angle.

For a 2 or 3 element yagi at HF (7 to 14 Mhz) approx heights are:  
(assuming average soil conductivity = 5 mS / meter dielectric constant = 13)

<u>TO Angle (degrees)</u>	<u>Height (feet)</u>	<u>Distance F2 Layer (miles)</u>
45	20	400-800
40	27	450-900
30	32	650-1,300
20	37	950-1,700
15	45	1,200-2,000
12	50	1,300-2,300
10	60	1,400-2,400

For a 2 or 3 element yagi at HF (21 to 28 Mhz) approx heights are:  
(assuming average soil conductivity = 5 mS / meter dielectric constant = 13)

<u>TO Angle (degrees)</u>	<u>Height (feet)</u>	<u>Distance F2 Layer (miles)</u>
45	20	200-400
40	27	225-450
30	32	325-650
20	37	475-850
15	45	600-1,000
12	50	675-1,150
10	60	700-1,200

# H.F. Antenna Analysis

## Theoretical Antenna Patterns

### 1/2 Wave Horizontal Dipole Antenna - 7 MHz

Height (feet)	Take Off Angle (deg)
17.2	90
34.4	61
51.6	38
68.8	28
86.0	22
103.2	19
120.4	16
137.6	14

Maximum gain (5.89 db) is obtained at 59 degrees.

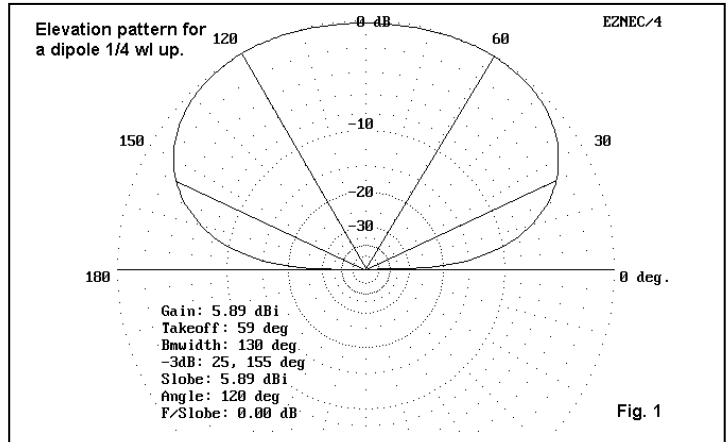

### Yagi Horizontal Antenna – 7 MHz

Height (feet)	Take Off Angle (deg)
17.2	58
34.4	45
51.6	34
68.8	27
86.0	22
103.2	18
120.4	16
137.6	14

Maximum gain (8.40 db) is obtained at 44 degrees.

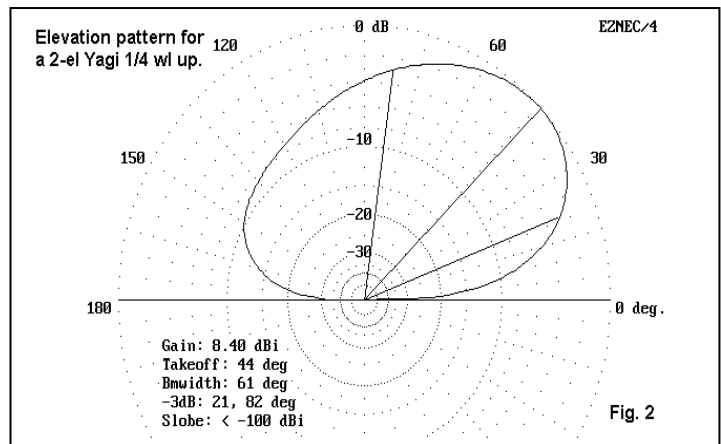

The Yagi improvement in elevation angle is mostly at the lowest heights. Above a half-wavelength, the take-off angle closely matches that of the dipole. The Yagi exhibits about 3 dB more gain than the dipole at the angle of maximum radiation, which is 44 degrees.

## The Vertical Dipole Antenna – 7 MHz

10' off the ground at lowest point  
 Feed point = 44'  
 Top = 78'

Maximum gain (0.24 db) is obtained  
 at 16 degrees.

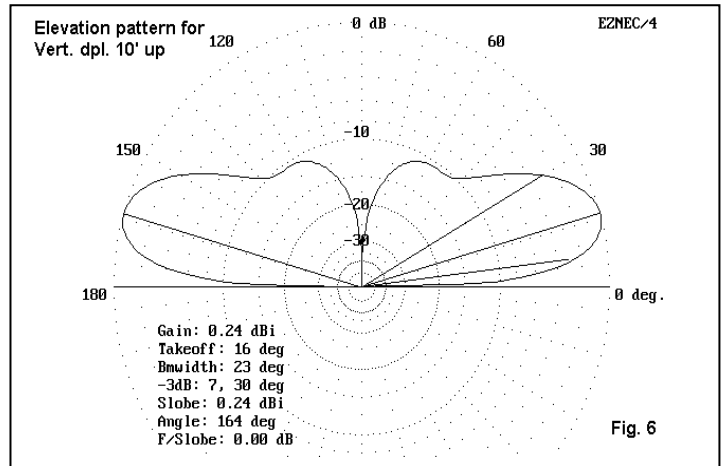

## 1/4 Wave Vertical Antenna Counterpoise

<u>Band (meters)</u>	<u>Length (meters)</u>	<u>Length (feet)</u>
10	2.5	8.2
12	3	9.84
15	3.75	12.3
17	4.25	13.94
20	5	16.4
30	7.5	24.6
40	10	32.8
60	15	49.2
80	20	65.6
160	40	131.2

## 1/2 Wave Vertical Antenna Counterpoise

<u>Band (meters)</u>	<u>Length (meters)</u>	<u>Length (feet)</u>
10	5	16.4
12	6	19.68
15	7	22.96
17	8.5	27.88
20	10	32.8
30	15	49.2
40	20	65.6
60	30	98.4
80	40	131.2
160	80	262.4

Feet = 3.28 meters

## Comparison of 1/2 Wave Horizontal Dipole and Yagi Antennas - 7 MHz

- Horizontal dipole
- Horizontal Yagi

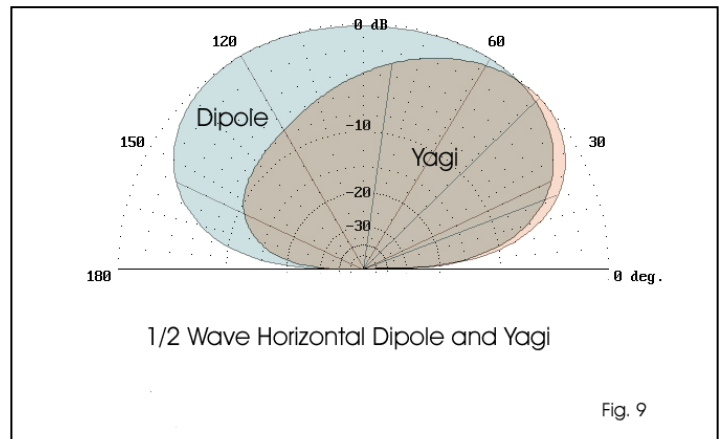

The horizontal dipole's maximum gain (5.89 db) is obtained at 59 degrees.

The horizontal Yagi's maximum gain (8.40 db) is obtained at 44 degrees.

The Yagi has slightly more gain in the lower angles of radiation. The horizontal dipole has a wider range.

## Comparison of 1/2 Wave Horizontal Dipole, Yagi, and Vertical Antennas - 7 MHz

- Horizontal dipole
- Horizontal Yagi
- Vertical Dipole

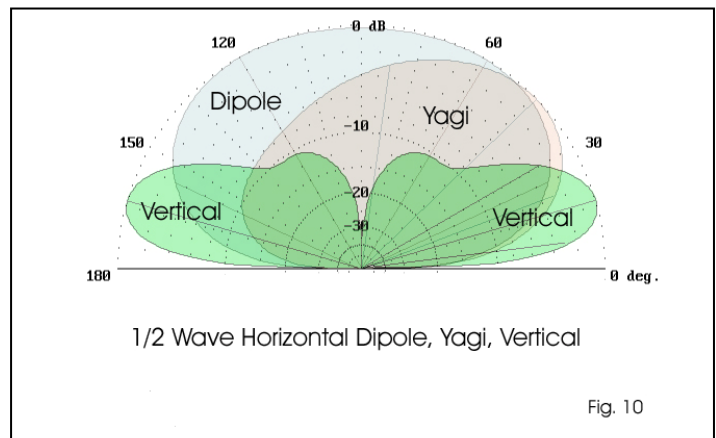

The horizontal dipole's maximum gain (5.89 db) is obtained at 59 degrees.

The horizontal Yagi's maximum gain (8.40 db) is obtained at 44 degrees.

The vertical's maximum gain (0.24 db) is obtained at 16 degrees.

The horizontal dipole has the widest overall coverage.

The Yagi offers slightly more gain at slightly lower radiation angle than the horizontal dipole.

The vertical has more gain at lower radiation angles, excellent for long-range transmission.



## Skip Distance, Skip Zones, and “Take Off” Angles of Radiation

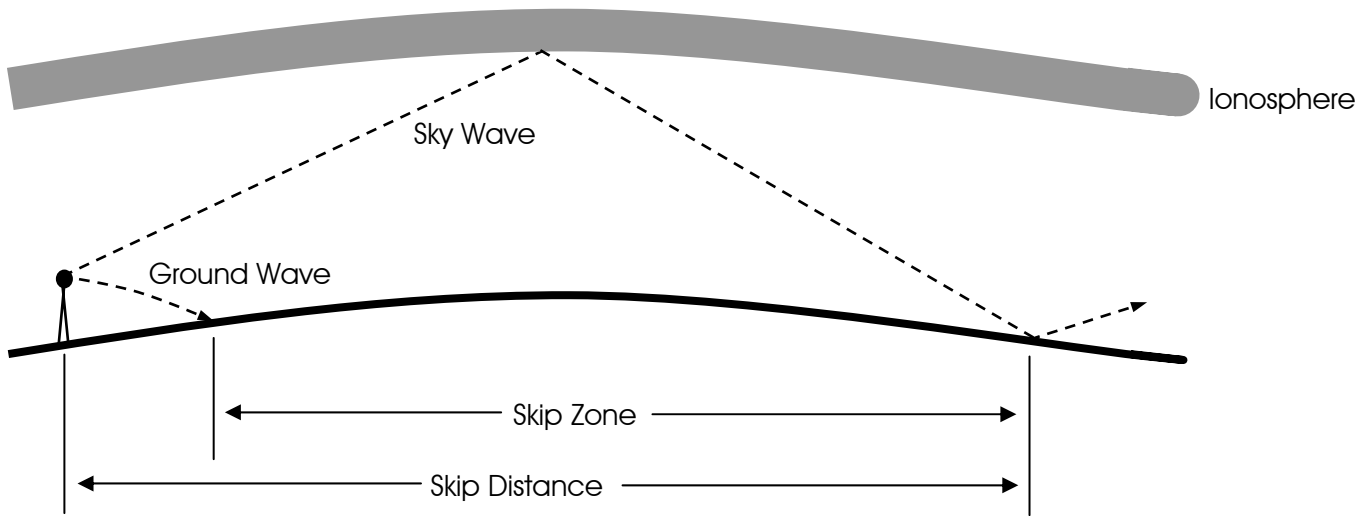

Antennas produce ground waves and sky waves.

A sky wave is a signal that travels toward the ionosphere and is reflected back down to earth. HF sky waves typically travel 100 to 8,000 miles. VHF sky waves typically travel 50 to 150 miles. The angle at which the sky wave is sent from the antenna to the ionosphere is called the “take off angle of radiation.” The angle of radiation or take off angle is dependent upon the antenna type, the height of the antenna, and the frequency of the electromagnetic wave.

A ground wave is a signal that runs along the Earth’s surface. It extends out from the antenna for up to about 50 miles. It is a limited signal, which allows for short distance communication.

A skip zone is an area where no signals will be received. Skip zones are formed when the nearest point at which a sky wave is received is beyond the furthest point at which a ground wave is received. When the ground wave coverage is great enough or the skip distance is short enough that no zone of silence occurs, there is no skip zone.

The ionosphere will reflect frequencies from 0.1 to 30 MHz.

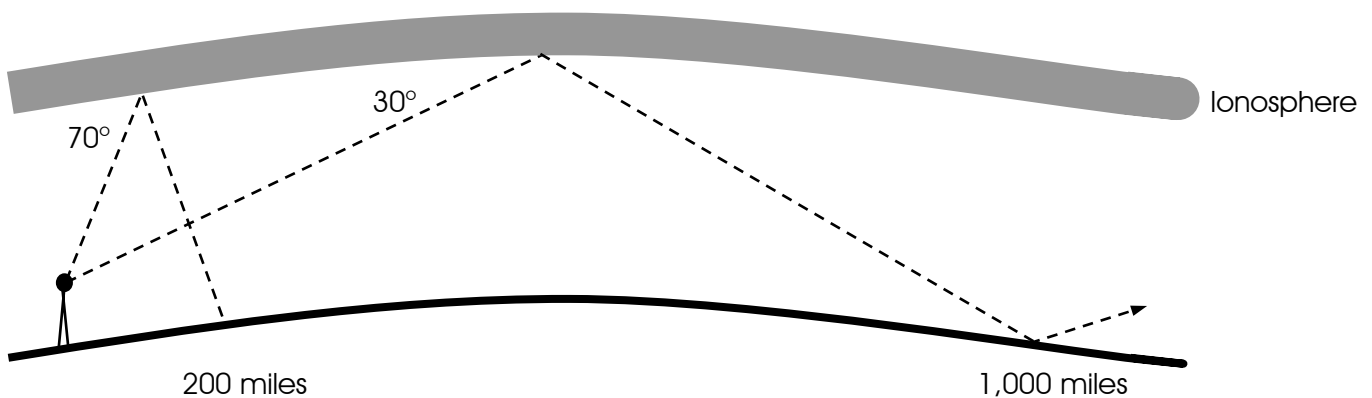

## Empirical Data

### Nassau Amateur Radio Club

#### Skip Zone (one hop) as a Function of Radiation Angle – 7 - 14 MHz. 2-3 element Yagi

<u>Height (feet)</u>	<u>Take Off Angle (deg)</u>	<u>Skip Zone F2 Layer (miles)</u>	<u>Miles Skipped</u>
20	45	400-800	400
*27	40	450-900	450
*29.5	35	675-975	300
*32	30	650-1,300	650
37	20	950-1,700	750
45	15	1,200-2,000	800
50	12	1,300-2,300	1,000
60	10	1,400-2,400	1,000

\* Best suited for Field Day. Skip distance is about 1,500 miles, which allows optimum coverage of the East coast where most of the Field Day contacts are. It would also still allow one hop coverage to the West coast (about 6 to 10 db down for a 2 or 3 element Yagi), with a double hop zone of about 12 to 18 db down due to multi-skip losses over mid US terrain.

### Nassau Amateur Radio Club

#### Skip Zone (one hop) as a Function of Radiation Angle – 21 - 28 MHz. 2-3 element Yagi

<u>Height (feet)</u>	<u>Take Off Angle (deg)</u>	<u>Skip Zone F2 Layer (miles)</u>	<u>Miles Skipped</u>
10	45	400-800	400
*13.5	40	450-900	450
*14.8	35	675-975	300
*16	30	650-1,300	650
18.5	20	950-1,700	750
22.5	15	1,200-2,000	800
25	12	1,300-2,300	1,000
30	10	1,400-2,400	1,000

\* Best suited for Field Day. Skip distance is about 1,500 miles, which allows optimum coverage of the East coast where most of the Field Day contacts are. It would also still allow one hop coverage to the West coast (about 6 to 10 db down for a 2 or 3 element Yagi), with a double hop zone of about 12 to 18 db down due to multi-skip losses over mid US terrain.

## Selecting an H.F. Antenna for Field Day

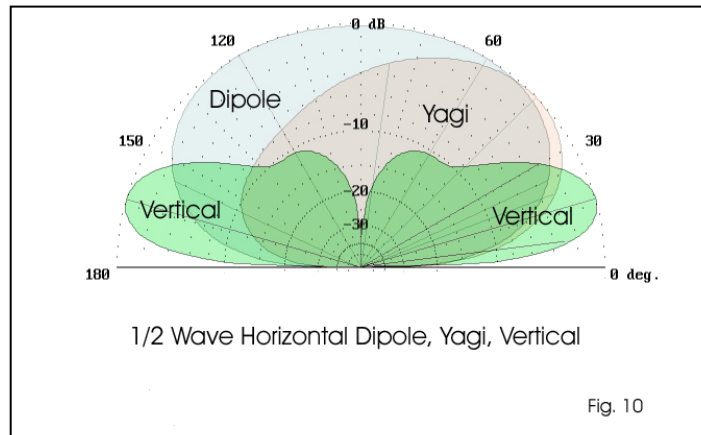

As indicated in Figure 10 above, the 1/2 wave vertical antenna will produce very good long-range communications because of its low angle of radiation. The 1/2 wave horizontal Yagi antenna will produce good long-range communications because it has slightly more gain in one direction and it has a lower angle of radiation. It also has much less gain in the reverse direction. The 1/2 wave horizontal dipole antenna will produce the best overall communications near and far because it has a wide angle of radiation in the forward and rear directions.

The horizontal 1/2 wave dipole will be chosen for use at Field Day because it has the best overall communications near and far. Most clubs are currently using dipole antennas for Field Day for the obvious reasons. As a secondary antenna, the Outbacker Outreach, which has been used in past Field Days, will continue to be used since it only takes a few minutes to set up. The Outbacker antenna is used by FEMA, U.S. Coast Guard, other military organizations, embassies and more.

There are two basic types of dipole antennas. The simple wire type that can be strung between two trees or a rigid aluminum tubing rotatable 1/2 wave dipole such as the Cushcraft D3 (10, 15, 20 meter) tri-band antenna. The rotatable dipole will facilitate communications in any direction by turning the mast. Either of these dipoles will provide excellent communications. The Van Gorden wire dipoles have factory-installed baluns. The Van Gorden D-20 (20 meter) wire dipole measures 33 feet in length.

Masts are available in many sizes and shapes. The Cushcraft D3 antenna weights only 9 pounds. Therefore a tower is not necessary. The mast can be rotated manually. Therefore, a 115 VAC powered rotator is not required. Furthermore, if there was an emergency, 12 volts may be the only power available. A mast of 24 feet can be constructed from 1-1/4" thick-wall (0.065") aluminum tubing and a public address speaker stand. A special guy ring can be made to allow the mast to be turned. There are also a number of different masts that can be obtained commercially or as military surplus.

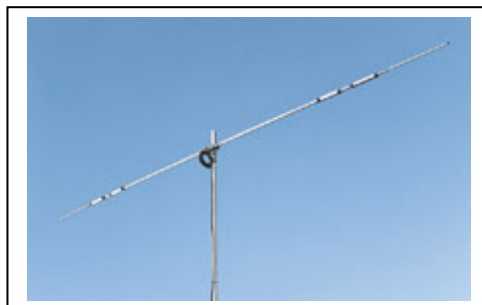

Cushcraft D3 – 25.8 feet long

# Mast and Antennas for Field Day & Emergencies

This is a 27 feet 1.5" diameter portable guyed mast with a 28 feet diameter footprint. It breaks down into four 6 feet sections plus the tripod. The total weight of the mast and tripod is 15 pounds. The homemade 1/4 wave dipole antenna weighs 3 pounds. The Cushcraft D3 antenna weighs 9 pounds. The mast can rotate even when guyed because of the special slip ring that is constructed.

## Mast Construction - Step 1

Cut the 1/8" x 4" x 12" aluminum plate to 1/8" 4" x 4". Drill a 1.75" hole in the center. Drill 3/8" holes as shown in Figure 1 and figure 2. File all burrs.

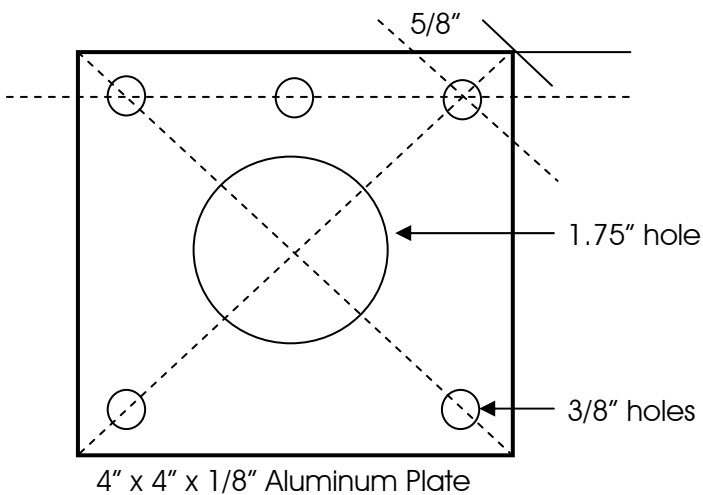

Figure 1

## Mast Construction - Step 2

Position the nylon shaft collar and tighten the set screw. Remove the set-screw and drill a 9/32" hole at the mark. Re-insert the set-screw and tighten. Add the nylon washer and silicon grease as shown in figure 3. Add the second nylon shaft collar and tighten the set screw. Remove the set-screw and drill a 9/32" hole at the mark. Add the 4" x 4" plate. Re-insert the set-screw and tighten as shown in figure 4 and figure 5. Rings for the guy ropes will be placed on the guy ring later. Three or four rings and guy ropes can be used.

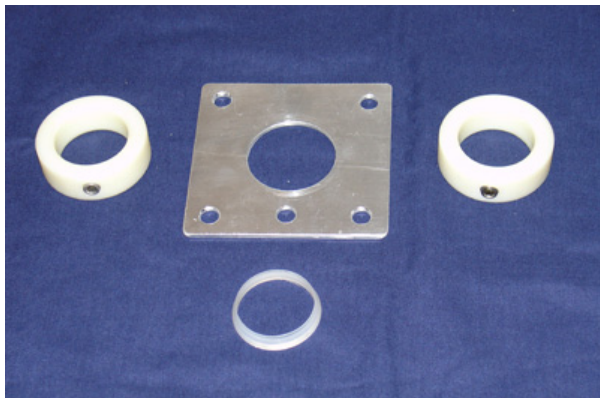

Figure 2

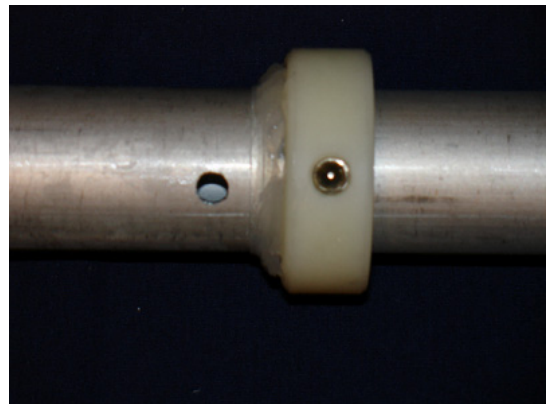

Figure 3

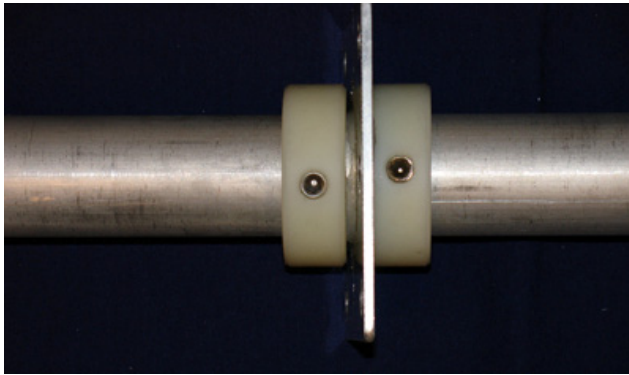

Figure 4



Figure 5

### Mast Construction - Step 3

Cut six 1.5" x 1.5" 90 degree aluminum pieces, 12 inches long. Drill four 5/16" holes, 1.5" and 4.5" from each end. Insert one 1.5" x 6 feet aluminum tube into the center. Drill 5/16" holes through the aluminum angles and through the aluminum tube as shown in figure 6. Place two 1/4-20 x 3" screws, washers and hex nuts through both pieces and tighten with a wrench. Repeat for the other end except use wing nuts in place of hex nuts so it can be disassembled easily. Repeat this process for the other two sections.

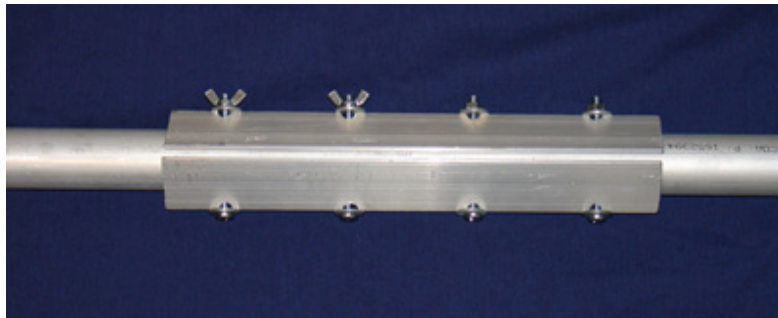

Figure 6

### Mast Construction - Step 4

Drill an 1 1/32" hole, 12 inches from the end of the bottom mast section so that the lock pin can be inserted as shown in figure 7.



Figure 7

## 1/4 Wave Dipole Antenna Construction

Cut a 21-inch length of 1.5" PVC pipe. Drill two 3/8" holes and insert coax cable, soldier lugs, bolt, lock washers, and 3/8-24 coupling nuts. Drill two 5/16" holes for mounting it to the mast as shown in figure 8. Drill a 1/4" hole on the bottom and secure the coax cable with a wire tire as shown in Figure 9 and figure 10. Drill holes in the top section of the mast so that the antenna can be attached. Tune two hamsticks with an antenna analyzer. Attach the two hamsticks to the coupling nuts.

### **1/4 Wave Dipole Antenna Test Results**

With the 20 meter dipole at a height of 24 feet, facing East and West from Northport, NY (altitude 187 feet), 5x9 reports were received from North Carolina, Georgia, Texas, and Pennsylvania. With the dipole facing North and South, 5x9 reports were received from as far as Argentina, South America. Propagation conditions were poor during this test (July 9, 2005).



Figure 8

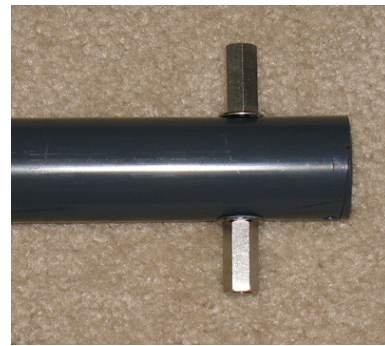

Figure 9



Figure 10

## Finally Assembly

Assemble all components. Attach the guy rings and 1/4" nylon rope. Tighten the clamp on the tripod. Place a 6 feet piece of wood against the tripod legs so that it will not slip when the mast is hoisted upward. Attach either the 1/4 wave dipole antenna or the Cushcraft 1/2 wave D3 dipole antenna as shown in figure 13. Place three stakes in the ground 14 feet from the mast as show in figure 14. If the D3 antenna is used, have one person lift the antenna while another person pulls on the guy rope. Once the mast and antenna are in place, tighten the guy ropes. Loosen the clamp on the tripod so that the mast can rotate. Figure 12 shows the tripod. Figure 11 shows the mast and D3 antenna in place.



Figure 11



Figure 12



Figure 13



Figure 14

## Parts List – Mast

Custom-made - Slip Ring 4" x 4" x 1/8" aluminum, 1-3/8" hole in center, 3/8" holes for rings

(1) McMaster-Carr 9041K12 – 4" x 12" x 1/8" aluminum strip, \$8.13

(4) McMaster-Carr 3885T11 - Spring snap rings, 2.5" overall length, \$1.60 each

(4) McMaster-Carr 89965K751 - 1.25" OD, 1.37" ID (0.065" wall), aluminum tubing, 6' length, \$32.91 each

(1) McMaster-Carr 8982K23 – 1.5" x 1.5" 90 degree angle, 1/8" thick aluminum, 8' length, \$22.55

(1) McMaster-Carr 90272A554 - 1/4-20 x 3" zinc plated screws (box of 100), \$14.35

(1) McMaster-Carr 98970A129 - 1/4" zinc plated washers (box of 100), \$3.11

(1) McMaster-Carr 90480A029 - 1/4-20 zinc plated hex nuts (box of 100), \$2.28

(1) McMaster-Carr 90866A029 - 1/4-20 zinc plated wing nuts (box of 100), \$8.38

(1) McMaster-Carr 4807K275 – 1-1/2" pipe seal ring, \$2.63

(2) McMaster-Carr 60475K82 – 1-1/2" ID, 2.25" OD set screws nylon shaft collar, \$10.92 each

200 feet 3827T37 – 1/4" diameter twisted nylon rope, \$18.62

(1) On Stage Model SS7761B Reversible 1-1/2" – 1-3/8" Speaker Stand (the tubing must be 1.5" in diameter and removable), \$49.95

(5) CampMor 23504 - Heavy Galvanized Steel Hook Stakes - 18 inch, \$3.29 each

(1) 3/4" x 4" x 6' wood for the ground to hold the tripod in place.

Silicon grease



## Parts List – 1/4 Wave Antenna

2 - 20 meter or other Hamsticks (they must be tuned with an antenna analyzer)

1 – PL259 connector

1 – UHF female to female adapter

2 feet RG8X cable

(2) 3/8" Soldier lugs (ring terminals)

(1) McMaster-Carr 7113K814 - 3/8" hole ring terminals, package of 10, \$1.71

21" piece of 1-1/4" ID PVC pipe

(1) McMaster-Carr 43415K35 1.660 OD, 1.278" ID, 1-1/4" PVC pipe, 5' length, \$18.44

(2) McMaster-Carr 90264A470– 3/8-24 x 1-3/4" coupling nuts, \$0.82 each

(2) McMaster-Carr 90108A417 – 3/8 washers, package of 100, \$3.88

(2) McMaster-Carr 91102A760 – 3/8 lock washers, package of 100, \$2.11

(2) McMaster-Carr 92620A654 – 3/8-24 x 3/4" hex bolts, package of 25, \$4.28

(2) McMaster-Carr 90276A572 - 1/4-20, 4" screws, package of 100, \$9.38

(4) McMaster-Carr 98970A129 - 1/4" zinc plated washers (box of 100), \$3.11

(2) McMaster-Carr 90866A029 - 1/4-20 zinc plated wing nuts (box of 100), \$8.38

# Cross Band and Fixed Band Repeaters

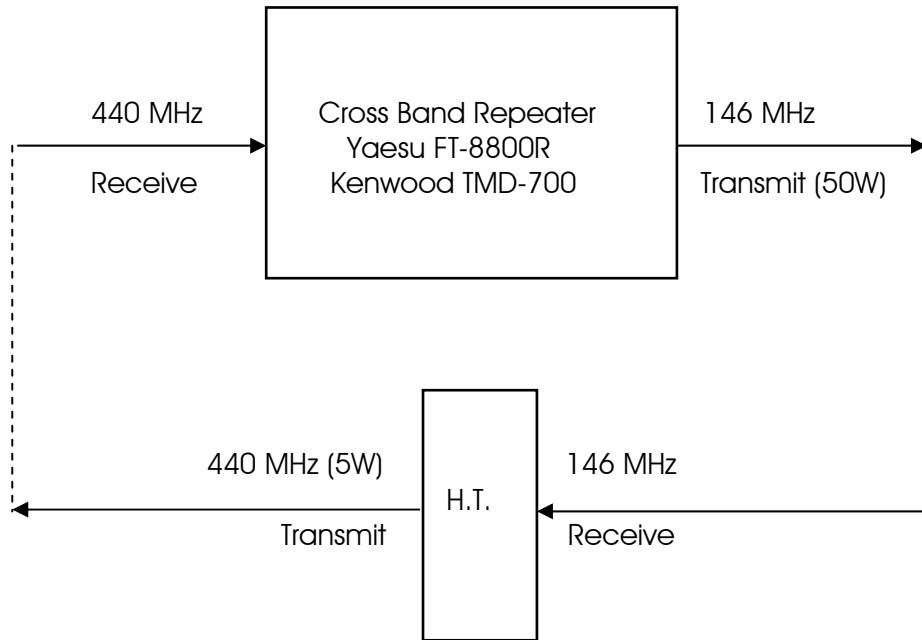

H.T must be dual band / dual receive so it can transmit on 440 MHz. and receive on 146 MHz.

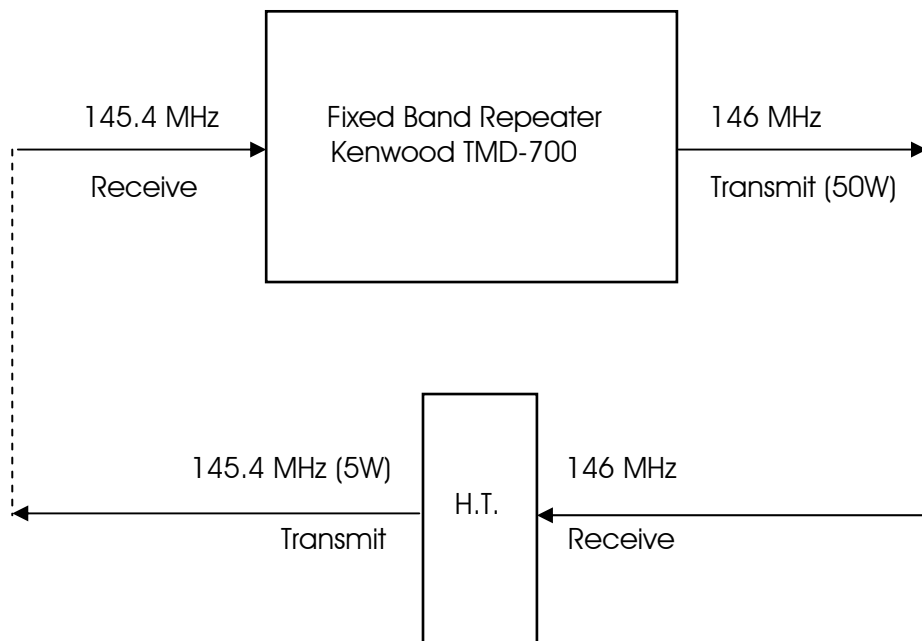

H.T can be a single band 2 meter transceiver with repeater offsets.

# Emergency Power

## Emergency Power Requirement Estimate

<u>Appliance</u>	<u>Rated Watts</u>	<u>x Hours/day</u>	<u>Surge Watts</u>	<u>Surge Watts</u>
Light Bulbs (75 watt each)	75 x number	_____	75 x number	_____
Compact fluorescent (25/100 watt)	25 x number	_____	25 x number	_____
Refrigerator/Freezer	500	_____	2000	_____
Sump Pump	800	_____	2000	_____
Water Pump (1/3 HP)	1000	_____	3000	_____
Furnace Fan (1/2 HP)	875	_____	2300	_____
Electric Blanket	400	_____	400	_____
Space Heater	1800	_____	1800	_____
Heat Pump	4700	_____	12000	_____
Dehumidifier	650	_____	800	_____
Attic Fan	300	_____	900	_____
Table Fan	800	_____	2000	_____
Window Air Conditioner	1200	_____	4800	_____
Central Air (10k BTU)	1500	_____	6000	_____
Central Air (24k BTU)	3800	_____	15000	_____
Central Air (40k BTU)	6000	_____	24000	_____
Computer	300	_____	300	_____
CD Player	100	_____	100	_____
VCR	100	_____	100	_____
Radio	100	_____	100	_____
Television	300	_____	300	_____

Amateur Radio Emergency Communications Training Course – Dr. John A. Allocca, WB2LUA

Receiver	420	_____	420	_____
Microwave	800	_____	800	_____
Blender	300	_____	900	_____
Coffee Maker	1500	_____	1500	_____
Electric Range (1 element)	1500	_____	1500	_____
Toaster (2-slice)	1000	_____	1600	_____
Dishwasher (Hot Dry)	1500	_____	3000	_____
Electric Oven	3410	_____	3410	_____
Steam Iron	1200	_____	1200	_____
Washing Machine	1150	_____	3400	_____
Gas Clothes Dryer	700	_____	2500	_____
Electric Clothes Dryer	5400	_____	6750	_____
Security System	500	_____	500	_____
Deep Freezer	500	_____	1000	_____
Hair Dryer	1200	_____	1200	_____
Garage Door Opener (1/3 HP)	750	_____	750	_____
Electric Water Heater	4000	_____	4000	_____
-----				
Total Per Day		_____		_____

Note: the generator must be able to handle the total surge power.

Note: Compact fluorescent (25/100 watt) bulbs provide an equivalent of 100 watts of light and use 25 watts of power.

## Generators

Generators are basically gasoline, natural gas, or propane powered. They usually generate substantial amounts of power. Portable generators commonly generate 1,000 to 5,000 watts continuously with a surge of about 1,300 to 6,500 watts. There are several disadvantages of gasoline powered generators. They require a constant refilling of gasoline and gasoline cannot be stored for long periods of time. Gasoline stations require electric pumps to supply gasoline and they may not have emergency generators. Natural gas is often available in many homes. Propane can be stored. Propane tanks are usually refilled by gas pressure, which eliminates the need for electric pumps.

## Solar Power

Solar power is far more expensive than generator power. There are several advantages of using solar power. Sunshine is the source of power, which eliminates dependency on vendors for fuel. Solar power is clean and requires little maintenance. The disadvantage is initial cost. Typically, solar power is used to charge batteries, which are connected to an inverter.

A solar cell or photovoltaic cell (PV) is made of semiconductors, usually silicon. Ordinarily pure silicon is a poor conductor of electricity so impurities such as phosphorus and boron are added to create the semi-conductor. The addition of these impurities allows the silicon to conduct electricity. The semiconductor absorbs part of the light. The absorbed light energy knocks electrons loose, allowing them to flow freely. Metal contacts are placed on the top and bottom of the solar cell so that current can be drawn from it.

A solar electric panel consists of an aluminum framed sheet of highly durable low reflective, tempered glass that has had individual solar cells adhered to the inner glass surface. These individual solar cells are wired together in a series parallel configuration to obtain the necessary voltage and current. The back of the panel is protected by another sheet of tempered glass or a long lasting material such as Tedlar. The series parallel connections are passed through the protective backing and then wired to a weather proof junction box which is permanently mounted to the back of the panel where the panel's output connections are made. There are also flexible cells and panels, roof tile cells, etc.

Solar panels are rated as watts per hour. For example, in direct sunlight, a 50 watt solar panel will produce 50 watts per hour. It will produce 350 watts in 7 hours, and so on.

## Batteries

When designing a marine deep cycle battery, manufacturers must keep in mind that the battery may be used for starting a boat's engine. In order to start an engine, the battery must contain a lot of plates and plate area, which give the battery its high cranking capacity. In order to squeeze enough plates into a standard battery case, the plates must be made thin. The thinner the plates the shorter the life span of the battery when it is used in a deep cycle application. If cost is a major factor and the batteries will only be used occasionally during an emergency, a marine deep cycle battery may be adequate.

A much better choice for long-term continuous use is the golf cart battery. The plates are much thicker and designed to be deep cycled below 50% depth of discharge day in and day out, year after year. A properly maintained golf cart battery should last 3 to 5 years in a typical renewable energy application. A typical golf cart battery is available in a 6 volt 220 amp hour ratings. Two batteries will be required and they will need to be wired in series to produce 12 volts @ 220 amp hours. Golf cart batteries are considered the minimum type of battery that is used in renewable energy application. There are larger batteries available in 6, 4 and even 2 volt configurations which have even larger plates and thus longer life expectancies.

When there is power available from the utility company, batteries can be charged from the power line. During emergencies, when there is no power from the utility company, batteries will have to be charged from the solar panel.

#### Calculating Battery Usage:

Amp Hour x Volts (Watts)  
----- = Watts per Hour  
Hours of Use

Amp Hour x Volts (Watts)  
----- = Hours of Use  
Watts per Hour

Example:

A 12 volt, 100 ah battery will provide:

100 amps in 1 hour (1200 watts in 1 hour)

14.3 amps for 7 hours (171 watts in 7 hours)

5 amps for 20 hours (60 watts in 20 hours)

#### Calculating the Load:

Watt Hours = Load Watts x Hours of Use  
Add 10 percent for battery losses.

Example: If a television draws 200 watts and runs for three hours (200 x 3 = 600) it will use 600 watt hours

## **Inverters**

An inverter is an electronic device, which inverts DC energy AC energy. Most household appliances such as refrigerators, TVs, lighting, stereos, computer etc., all run off of AC electricity.

Modern DC to AC inverters are very reliable, quiet, and require virtually no maintenance. There are two different types of DC to AC inverters in common use today. The first type of inverter is known as a modified sine wave inverter. This type of inverter is very high in efficiency and produces a waveform, which is an approximation of the pure sine wave waveform.

High frequency units take the incoming 12 Volts DC and will step up that voltage to approximately 200 volts DC through a high frequency DC to DC converter circuit and then will take the 200 Volts and will wave shape it into a modified sine wave using a using a device called a high voltage H-bridge. The high voltage H-bridge is basically a group of field effect transistors that are arranged in such a way as to form the necessary half cycles that create the modified sine wave at the 60 Hz frequency required for US appliances. By utilizing high frequency, the need for a large iron core output transformer is eliminated and much smaller transformers can be used. As a result of this, high frequency inverters tend to be much lighter but do have a lower surge capacity because they lack the fly wheel effect found in heavy iron core output transformer based inverters.

Low frequency units take the incoming 12 Volts DC and converts it into AC, using a multivibrator or microprocessor based circuit. The AC is kept at a low voltage and is converted into a 60 Hz signal before it is fed to the iron core transformer. Wave shaping and the increased current that is needed to drive the transformer is performed again by an H-bridge which is a group of field effect transistors that are arranged in such a way as to feed high current pulses to the primary windings of the transformer at precise moments of each wave form half cycle. The transformer converts the lower voltage which was fed to its primary windings into 120 Volts AC at its secondary windings using simple transformer step up principles involving a 10 to 1 ratio, converting 12 Volts AC to 120 AC. This type of inverter is more durable than the high frequency inverters, and has a much higher surge capacity. Low frequency units tend to cost two to five times more than do high frequency units and often weigh four times more.

The second type of inverter is known as a pure sine wave inverter. This type of inverter produces pure sine waves, but at the cost of some efficiency loss and at a much higher price. Most pure sine wave inverters are typically priced at least 75% higher than the modified sine wave counterparts and in some cases do not have as high of a surge capability as do modified sine wave units.

### A 3,000 Watt, 120 VAC, Output Solar System

The Batteries will need to supply 3,600 watts of electricity per hour, 86,400 watts per day. The inverter efficiency is about 71 percent. Therefore 3,600 watts DC will be needed to convert to 3,000 watts AC. The solar panels will need to charge the batteries with 86,400 watts during sunlight (about 7 hours per day) at the rate of 12,342.9 watts per hour. The system will require a space of about 30 feet x 30 feet, weigh more than 7,000 pounds, and cost over \$60,000.

Calculate Time of Battery Use:

$$\frac{\text{Amp Hour x Volts (Watts)}}{\text{Watts per Hour}} = \text{Hours of Use} = \frac{400 \text{ ah} \times 6 \text{ volts} \times 36 \text{ batteries}}{3600 \text{ watts per hour (150 a} \times 24 \text{ v)}} = 24 \text{ hours}$$

Calculate Time of Battery Recharge from Solar Panels:

$$\frac{\text{Amp Hours x Volts (Watts)}}{\text{Solar Panel Watts}} = \frac{400 \text{ ah} \times 6 \text{ volts} \times 36 \text{ batteries}}{66 \times 185 \text{ watts per hour}} = 7.1 \text{ hours}$$

The system consists of:

Sixty Six 185 watt, 24 v solar panels, 62" x 32.5" x 1.8", 38 pounds, (about \$50,000)

Connected in parallel (923.6 square feet [30' x 30'], 2,508 pounds)

3,600 watt output, 24 volt - 210 amp input (150 amp input at 3000 watt output), modified sine wave inverter (about \$1,800)

Three 60 amp charge controllers (about \$600)

Thirty six 400 ah, 6 volt, 127 pound batteries connected in series and parallel for 24 v (about \$7,700 and 4,572 pounds)

Miscellaneous cables, etc.



# U.S. Amateur Bands

February 23, 2007      Extra (E), Advanced (A), General (G), Technician (T), Technician Plus (T+), Novice (N)

## 160 Meters

E, A, G      1.8 – 2.0 MHz CW, Phone, Image, RTTY/Data

## 80 Meters

E	3.500 - 3.600 MHz CW, RTTY/Data	3.600 - 4.0 MHz CW, Phone, Image
A	3.525 – 3.600 CW, RTTY/Data	3.700 – 4.0 MHz CW, Phone, Image
G	3.525 – 3.600 CW, RTTY/Data	3.800 – 4.0 MHz CW, Phone, Image
N, T+	3.525 – 3.600 CW only	

## 60 Meters (USB phone only to five discrete 2.8-kHz-wide channels, 50 W ERP max. power, tune 1.5 kHz lower)

E, A, G      5.332 (5.3305), 5.348 (5.3465), 5.368 (5.3665), 5.373 (5.3715), 5.405 (5.4935) MHz.

## 40 Meters

E	7.000 – 7.125 MHz CW, RTTY, Data	7.125 – 7.300 MHz CW, Phone, Image
A	7.025 – 7.125 CW, RTTY/Data	7.125 – 7.300 MHz CW, Phone, Image
G	7.025 – 7.125 CW, RTTY/Data	7.175 – 7.300 MHz CW, Phone, Image
N, T+	7.025 – 7.125 CW only	

## 30 Meters

E, A, G      10.100 – 10.150 MHz CW, Image, 200 watt maximum.

## 20 Meters

E	14.000 – 14.150 MHz CW, RTTY, Data	14.150 – 14.350 MHz CW, Phone, Image
A	14.025 – 14.150 CW, RTTY, Data	14.175 – 14.350 MHz CW, Phone, Image
G	14.025 – 14.150 CW, RTTY/Data	14.225 – 14.350 MHz CW, Phone, Image

## 17 Meters

E, A, G      18.068 – 18.110 MHz CW, RTTY/Data      18.110 – 18.168 MHz CW, Phone, Image

## 15 Meters

E	21.000– 21.200 MHz CW, RTTY/Data	21.200 – 21.450 MHz CW, Phone, Image
A	21.025 – 21.200 CW, RTTY/Data	21.225 – 21.450 MHz CW, Phone, Image
G	21.025 – 21.200 CW, RTTY/Data	21.275 – 21.450 MHz CW, Phone, Image
N, T+	21.025 – 21.200 CW only	

## 12 Meters

E, A, G      24.890 – 24.930 MHz CW, RTTY, Data      24.930 – 24.990 MHz CW, Phone, Image

## 10 Meters

E, A, G	28.000 – 28.300 MHz CW, RTTY/Data	28.300 – 29.700 MHz CW, Phone, Image
N, T+	28.000 – 28.300 MHz CW, RTTY/Data	28.300 – 28.500 MHz Phone, CW, 200 watts PEP max

## 6 Meters

E, A, G, T, T+      50.0 – 50.1 MHz CW only      50.1 – 54.0 MHz CW, Phone, Image, MCW, RTTY/Data

## 2 Meters

E, A, G, T, T+      144.0 – 144.1 MHz CW only      144.1 – 148.0 MHz CW, Phone, Image, MCW, RTTY/Data

**1.25 Meters**

E, A, G, T, T+, Novice limited to 25 Watts

222 – 225 MHz CW, Phone, Image, MCW, RTTY/Data

**70 Centimeters**

E, A, G, T, T+

420 – 450 MHz CW, Phone, Image, MCW, RTTY/Data

**23 Centimeters**

E, A, G, T, T+

Novice limited to 5 watts

1240 – 1300 MHz CW, Phone, Image, MCW, RTTY/Data

1270 – 1295 MHz CW, Phone, Image, MCW, RTTY/Data

**Higher Frequencies**

All modes and licensees (except Novices) are authorized on the following bands [FCC Rules, Part 97.301(a)]:

2300-2310 MHz

2390-2450 MHz

3300-3500 MHz

5650-5925 MHz

10.0-10.5 GHz

24.0-24.25 GHz

47.0-47.2 GHz

75.5-81.0 GHz\*

119.98-120.02 GHz

142-149 GHz

241-250 GHz

All above 300 GHz

\* Amateur operation at 76-77 GHz has been suspended till the FCC can determine that interference will not be caused to vehicle radar systems

# Amateur Radio Call Sign Numerical Prefixes

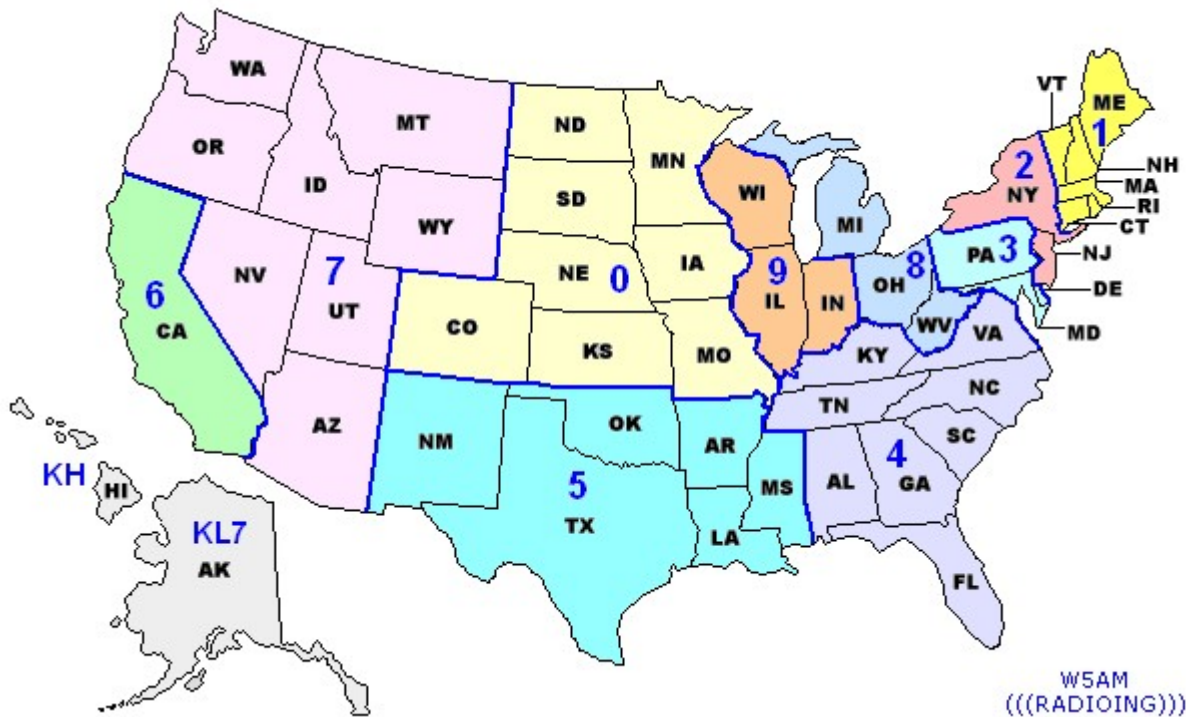

## Region 1

Maine (ME)  
New Hampshire (NH)  
Vermont (VT)  
Massachusetts (MA)  
Rhode Island (RI)  
Connecticut (CT)

## Region 2

New York (NY)  
New Jersey (NJ)

## Region 3

Pennsylvania (PA)  
Delaware (DE)  
Maryland (MD)

## Region 4

Kentucky (KY)  
Virginia (VA)  
Tennessee (TN)  
North Carolina (NC)  
South Carolina (SC)  
Alabama (AL)  
Georgia (GA)  
Florida (FL)

## Region 5

Texas (TX)  
New Mexico (NM)  
Oklahoma (OK)  
Arkansas (AR)  
Louisiana (LA)  
Mississippi (MS)

## Region 6

California (CA)

## Region 7

Washington (WA)  
Oregon (OR)  
Idaho (ID)  
Montana (MT)  
Wyoming (WY)  
Nevada (NV)  
Utah (UT)  
Arizona (AZ)

## Region 8

Michigan (MI)  
Ohio (OH)  
West Virginia (WV)

## Region 9

Wisconsin (WI)  
Illinois (IL)  
Indiana (IN)

## Region 0

North Dakota (ND)  
South Dakota (SD)  
Minnesota (MN)  
Nebraska (NE)  
Iowa (IA)  
Colorado (CO)  
Kansas (KS)  
Missouri (MO)

\* Additional U.S. Prefixes: KL7  
- Alaska (AK), KH6 - Hawaii (HI)

## FCC Regional Call sign Groups

A unique call sign is assigned to each amateur station during the processing of its license application. The station is reassigned this same call sign upon renewal or modification unless application for a change is made. Each call sign has a one letter prefix (K, N, W), or a two letter prefix (AA-AL, KA-KZ, NA-NZ, WA-WZ), and a one, two, or three letter suffix separated by a numeral (0-9) indicating the geographic region. When the call signs in any regional-group list are exhausted, the selection is made from the next lower group. The groups are:

Group A: Primary stations licensed to Amateur Extra Class operators. Regions 1 through 10 - prefix is the letter K, N, or W, and a two letter suffix; or a two letter prefix with first letter A, N, K, or W, and one letter suffix; or two letter prefix with first letter A, and two letter suffix.

Group B: Primary stations licensed to Advanced Class operators. Regions 1 through 10 - prefix is two letters with the first letter K, N, or W, and a two letter suffix.

Group C: Primary stations licensed to General, Technician, and Technician Plus Class operators. Regions 1 through 10 - prefix is the letter K, N, or W, and a three letter suffix.

Group D: Primary stations licensed to Novice Class operators, and for club and military recreation stations. Regions 1 through 10 - prefix is two letters with first letter K or W, and three letter suffix.

## Anderson Powerpoles<sup>®</sup>

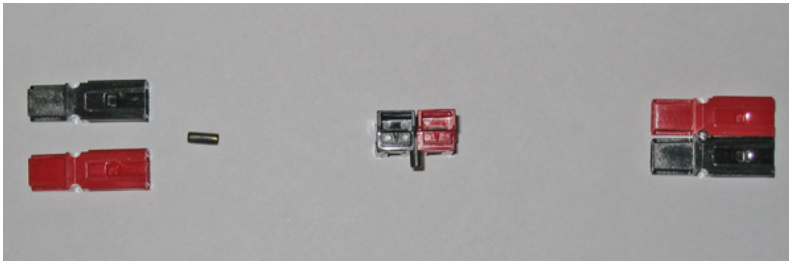

Figure 1

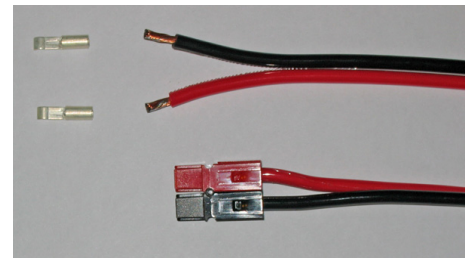

Figure 2

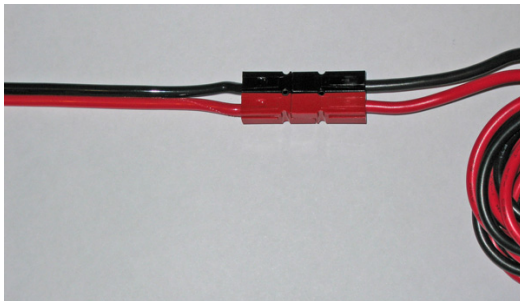

Figure 3



Figure 4



Connectors should be aligned in this direction  
(Red on the Right with the conductor on the top)

One of the nicest features of Anderson Powerpoles<sup>®</sup> is that there are no male or female connectors. To connect them together, simply turn one or one set of connectors upside down. This makes them universal and can be used to connect various pieces of equipment easily, even to someone else's power supply.

Start with a set of black and red connectors. Several other colors are available. Slide them together and insert the pin between them as seen in Figure 1.

Next, strip off 1/4" of insulation and slightly tin the wires. Solder the metal connectors to the wires. I find crimping makes it very difficult if not impossible to insert the metal pieces into the plastic shell. After soldering the wires to the metal connectors, allow them to cool. Then insert them into the plastic shells as seen in Figure 2.

To connect to sets of cable together, simply turn one pair upside down and push together as seen in Figure 3.

You can come off the power supply with a double cable as seen in Figure 4. Adapter and junction cables are available commercially. There are also fuse blocks (Rig Runners) and more available commercially.

# ITU Phonetic Alphabet

A - Alpha

B - Bravo

C - Charlie

D - Delta

E - Echo

F - Foxtrot

G - Golf

H - Hotel

I - India

J - Juliet

K - Kilo (pronounced keelo)

L - Lima (pronounced leema)

M - Mike

N - November

O - Oscar

P - Papa

Q - Quebec (pronounced kaybek)

R - Romeo

S - Sierra

T - Tango

U - Uniform

V - Victor

W - Whiskey

X - X-ray

Y - Yankee

Z - Zulu

## International Q Signals

QRA - What is your call sign?

QRG - Will you tell me my exact frequency (or the frequency of...)?

QRH - Does my frequency vary?

QRI - What is the tonal quality of my transmission?

QRJ - Are you receiving my transmissions poorly?

QRK - What is the intelligibility of my signals?

QRL - Are you/is the frequency busy? More!

QRM - Is there man-made interference to my transmissions? More!

QRN - Are you troubled by static or some other natural source of noise? (ok, cut the jokes ;-) More!

QRO - Shall I increase power? More!

QRP - Shall I decrease power? More!

QRQ - Shall I send faster? More!

QRS - Shall I send more slowly?

QRT - Shall I stop sending? More!

QRU - Do you have anything for me?

QRV - Are you ready? More!

QRX - When will you call me again?

QRY - What is my turn?

QRZ - Who is calling me?

QSA - What is the strength of my signals?

QSB - Are my signals getting weaker? More!

QSD - Is my keying defective?

QSG - Shall I send (number) messages at a time?

QSK - Can you hear me in between your signals and may I break in? More!

QSL - Can you acknowledge receipt? More!

QSLL - I will QSL on receipt of your QSL card. More!

QSM - Shall I repeat the last message I sent to you?

QSN - Did you hear my transmissions on (frequency)?

QSO - Can you communicate with me? More!

QSP - Will you relay to (station)?

QST - General call preceding a message addressed to all Amateurs. More!

QSU - Shall I send or reply on this frequency?

QSW - Will you send on this frequency?

QSX - Will you listen on (frequency)?

QSY - Shall I change transmission to another frequency?

QSZ - Shall I send each word or group more than once?

QTA - Shall I cancel message (number)?

QTB - Do you agree with my word count?

QTC - How many messages do you have to send?

QTH - What is your location?

QTR - What is the correct time?



# Signal Reporting

<u>Characteristics</u>	<u>Readability</u>	<u>Signal Strength</u>
1	Unreadable	Faint signals, barely perceptible
2	Barely readable, occasional words distinguishable	Very weak signal
3	Readable with considerable difficulty	Weak signal
4	Readable with practically no difficulty	Fair signal
5	Perfectly readable	Fairly good signal
6		Good signal
7		Moderately strong signal
8		Strong signal
9		Extremely strong signal

A signal report "5 by 9" would indicate that the readability is "5" (perfectly readable) and the signal strength is "9" (strong signal)

## CTCSS (PL) Tone Frequencies

The purpose of CTCSS is to reduce co-channel interference during band openings. CTCSS repeaters would respond only to signals having the CTCSS tone required for that repeater. These repeaters would not respond to distant weak signals on their inputs and would not repeat those signals. Listed are the standard Electronic Industries Association (EIA) frequency codes, in hertz, along with their Motorola alphanumeric designators.

67.0 – XZ	151.4 - 5Z
69.3 – WZ	156.7 - 5A
71.9 – XA	162.2 - 5B
74.4 – WA	
77.0 – XB	167.9 - 6Z
79.7 – WB	173.8 - 6A
82.5 – YZ	179.9 - 6B
85.4 – YA	
88.5 – YB	186.2 - 7Z
	192.8 - 7A
91.5 – ZZ	
94.8 – ZA	203.5 - M1
97.4 – ZB	203.5 - M1
100.0 - 1Z	206.5 - 8Z
103.5 - 1A	206.5 - 8Z
107.2 - 1B	
	210.7 - M2
110.9 - 2Z	218.1 - M3
114.8 - 2A	225.7 - M4
118.8 - 2B	
	229.1 - 9Z
123.0 - 3Z	
127.3 - 3A	
131.8 - 3B	233.6 - M5
	241.8 - M6
136.5 - 4Z	250.3 - M7
141.3 - 4A	
146.2 - 4B	254.1 - 0Z

# Mobile Emergency Communications Center

## Introduction

A mobile emergency communications center (MECC) was needed for practice sessions (“Mini Field Days”) and for emergencies. A 6 x 14-foot (6 x 12) v-nose trailer was eventually chosen because it provides a large amount of space at a low cost. It is also light enough (1,320 pounds) to be towed by most cars. A small window, which opened and closed, was added to the trailer. The inside walls were removed. Insulation was placed in the spaces and the walls were replaced. A 6-foot console with shelves was constructed out of birch plywood. All of the equipment was built on wooden boards with rubber feet, which are held in place on the shelves with Velcro for easy removal. An 8-foot length of 2” angle aluminum (1/8” thick) was attached to the outside of the trailer. Four 5/8” holes were made in the aluminum with a Greenlee cutter. Four SO-239 base connectors were attached to the aluminum. Two HF hamsticks were attached using the AD-35 adapter. Two VHF/UHF antennas were also attached. At the nose of the trailer, two 4” wall mounts were attached at a height of 4 feet. The 12’ mast with two hamsticks was connected to the wall mounts yielding an overall height of 16 feet. Wires were fed through the trailer using plastic electrical lead-in boxes. An AC box was also added to bring 120 vac into the trailer. The equipment modules were made with switches to instantly change from AC to battery power. A 4-drawer file cabinet was added to store cables, tools, etc. Hooks were strategically placed around the inside of the trailer to tie down large accessories and chairs with bungee cords. The 10’ x 10’ canopy/tent, table, and folding chairs is used to provide an outdoor eating/relaxation area. Plans to build the 15’ and 27’ antenna masts and 1/4 wave rotatable dipole can be found in a previous chapter. The project took 1 week to complete. The total cost was \$14,747.

## Modalities

- VHF/UHF dual band voice
- VHF/UHF dual band voice
- VHF/UHF dual band packet / Winlink 2000
- VHF APRS
- VHF/UHF SSTV
- HF SSTV
- HF Voice (including 60 meters)
- HF Voice
- HF Pactor / Winlink 2000
- HF PSK31

## Antennas

- Diamond NR-770H VHF/UHF antenna for VHF/UHF voice and packet
- Diamond NR-770H VHF/UHF antenna for VHF/UHF voice and APRS
- Diamond X50A VHF/UHF antenna for VHF/UHF voice, packet, APRS
- HF hamstick antennas for 10 meters (2 for dipole and one for vertical)
- HF hamstick antennas for 20 meters (2 for dipole and one for vertical)

- HF hamstick antennas for 40 meters (2 for dipole and one for vertical)
- HF hamstick antennas for 60 meters (2 for dipole and one for vertical)
- HF hamstick antennas for 75 meters (2 for dipole and one for vertical)
- 12' 1/4 wave rotatable dipole with hamsticks
- 27' 1/4 wave rotatable dipole with hamsticks / Cushcraft 1/2 wave D3
- 20 meter wire dipole antenna
- Outpost Tripod (can be used with hamsticks)
- 4 Comet 3D5MC SO-239 mounts with cables (for 5/8" hole)

## Equipment

- Yaesu FT-8800R VHF/UHF radio
- Kantronics KPC3 plus TNC
- MFJ 4125 25 amp switching AC power supply
- Yaesu FT-897D VHF/UHF/HF (including 60 meters) radio
- Yaesu FP-30 internal AC power supply
- Kenwood TS-570D HF Radio
- Rigblaster sound card interface
- SCS PTC-Ilex Pactor II/III modem
- Samlex SEC-1223 23 amp switching power supply
- Kenwood TMD-700A VHF/UHF radio for voice and APRS
- Samlex SEC-1223 23 amp switching power supply
- Garmin Emap GPS receiver with external antenna for APRS
- 4 MFJ 281 External speakers
- SGC Mac-200 automatic tuner
- Kenwood TH-D7A Dual Band HT
- Dell D510 Laptop computer
- Hewlett Packed 3650 color printer
- Radio Shack scanner
- 2 Marine Deep Cycle 12 volt batteries
- 12 volt deep cycle battery charger
- 375 watt inverter
- Koss QZ/99 headphones
- 120 volt AC cables
- RG8U mini cables
- 2 suppressor AC outlet strips
- RigRunner 4008 Anderson Powerpole 8 x 12 volt strip
- Clock
- Tools and tool box
- Flash lights and batteries
- 2 clamp on desk lamps with 15w compact fluorescent bulbs
- 10,000 BTU portable air conditioner
- Portable ceramic element heater
- 0 – 15 volt panel meter
- AM/FM broadcast band portable radio
- MFJ-259B Antenna Analyzer

## Miscellaneous

- First Aid Kit
- 2 Hard hats
- 2 Tyvec Suits
- 2 Fume masks
- 6 work gloves
- Stationary supplies
- Paper cups
- Paper towels
- Towels
- Rain gear
- 72 inch console / desk with shelves (custom built)
- 4 swivel desk chairs
- 4 folding chairs
- 30 inch square folding table
- 10' x 10' canopy
- Coleman Weathermaster™ Cabin 12 ft. x 9 ft. 2-Room Tent
- Eureka 13ft. 6in. x 9ft. 6in. Screen House
- Accessory cables, connectors, fuses, etc.

## Photos

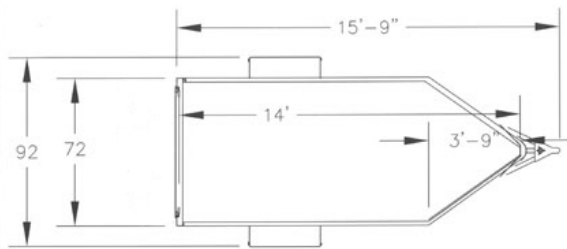



# Emergency Communications Backpack Radio

## Introduction

What do you do if the repeaters are down or you can't reach the repeaters or anyone with a 5 watt handheld radio in the middle of nowhere? You need a lightweight 5-50 watt portable radio with a substantial antenna and ground system.

The high powered backpack radio consists of a Yaesu FT-8900R, 5-50 watt, 10 m / 6 m / 2 m / 70 cm, battery powered radio with a diamond CR-8900 10 m / 6 m / 2 m / 70 cm antenna at height of about 9 feet and a 17 foot ground plane. The folder over antenna can be operated vertically or horizontally depending upon whether or not there are obstructions in the way. Under normal conditions, this radio and antenna combination does not require a tuner. It also does not require a duplexer.

There are a number of 10 meter FM repeaters that can be reached when VHF/UHF are not in the line of sight. Ten meters can be used over long distances. This system can also be used as a stand alone radio with the legs folded down as well as a cross band repeater along with several handheld radios. If there is an AC outlet nearby, keep the charger connected so that the battery will charge as it is used. Headphones will minimize environmental noise. The separation kit is used to bring the controls to the front of the backpack. If it is raining, the controls must be covered with plastic.

Why not use an HF/VHF/UHF radio? It can be done. However, an HF/VHF/UHF radio will add extra weight, a larger antenna, and a tuner, which will require tuning to a station whereas this configuration will not require tuning if properly configured.

Construct a wooden box to fit snugly inside the backpack. The battery, radio, and antenna pole are mounted to the box. A 12 foot length of tinned copper flat braid is mounted on and around the sides and bottom of the wooden box by looping it back and forth. Do not coil the braid. The tinned copper brain is connected to the radio ground with a 15 inch piece of tinned copper braid. The ground plane consists of the 5 foot pole and 12 feet of tinned copper flat braid, making a total ground plane of 17 feet. Anderson power pole connectors are used to connect the radio, battery, and charger together. Construct a bracket and legs as shown below. The total weight is 21 pounds.

<u>Mode</u>	<u>Measured Power Draw</u>	<u>Estimated Battery Life</u>
Receive	0.27 amps	25.9 hours
5 Watts Output	2.15 amps	3.26 hours
10 Watts Output	2.86 amps	2.45 hours
20 Watts Output	4.01 amps	1.75 hours
50 Watts Output	7.42 amps	0.94 hours (56 minutes)

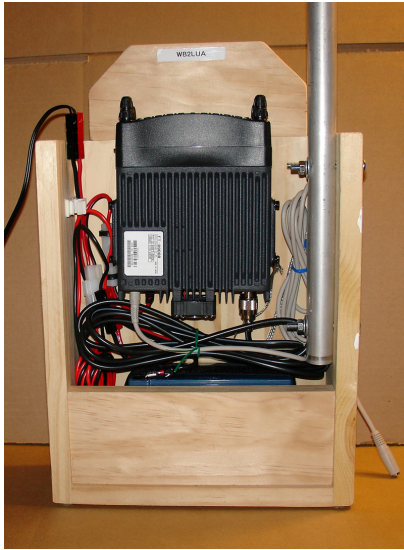

Wooden Case & Battery



Pole & UHF Connector

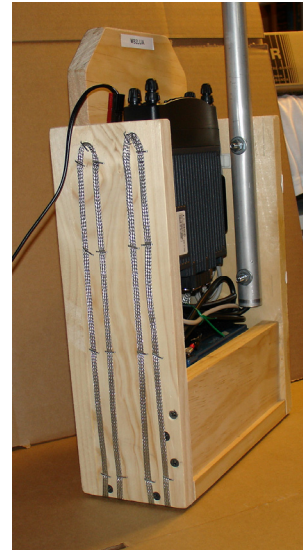

Looped Tinned Copper Braid

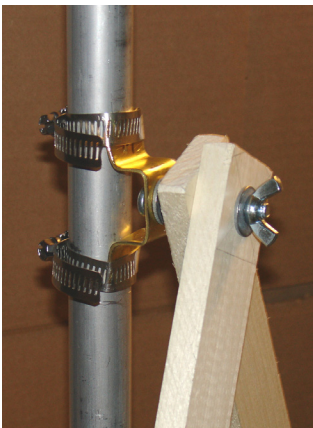

Clamp, Bracket, and Legs

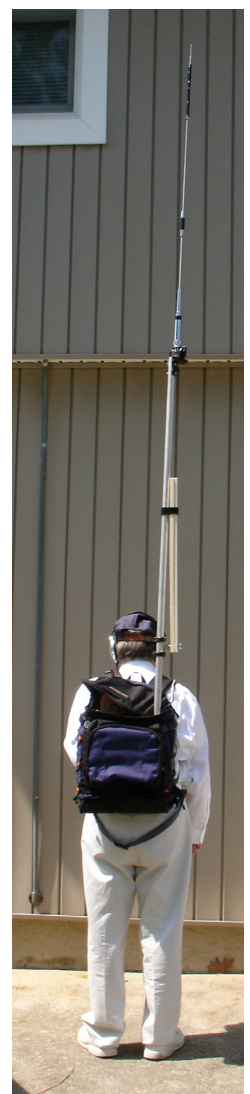



## Parts List

Yaesu FT-8900R 10 m / 6 m / 2 m / 70 cm, 5-50 watt radio  
Yaesu YSK-8900 separation kit  
Diamond K550 rail mount  
Comet 3D4M UHF mount with 13.5 feet of low loss cable and PL-259 connector  
Diamond CR8900A, 10 m / 6 m / 2 m / 70 cm, 50" fold over antenna  
60 inch length of 1 inch O.D., 0.035" wall, aluminum tubing  
Power Sonic PS-1270F1, 12 volt, 7.0 AH, sealed lead acid battery  
Ault, Inc, BA500120500003BK, automatic 12 volt charger  
6 sets of Anderson power pole connectors  
2 female disconnects 0.25"  
12 feet of 1/4 inch tinned copper flat braid  
15 inches of 1/4 inch tinned copper flat braid  
3/4 inch pine wood as needed  
2 1/4-20 2.5 inch screws  
6 1/4-20 washers  
2 1/4-20 lock washers  
2 1/4-20 nuts.  
1/4 inch staples  
1-5/8 inch wood screws  
Backpack  
Pair of over-the-ear headphones

# Quick-Install-Uninstall VHF/UHF Mobile Radio

## Introduction

Installing a radio transceiver can be time consuming and often one encounters a number of problems such as vehicle navigation, RF sensitive equipment, and antenna mounting. The system in this project can be quickly installed and a quickly uninstalled.

## Possible Vehicle Damage

There are some new vehicles that are so sensitive to RF, a mobile radio cannot be installed in any manner whatsoever. The navigation system on some vehicles can be damaged if the radio transceiver is not installed correctly. To install a radio transceiver correctly, there must be a good antenna ground, such as the trunk lip mount, where the screws are set directly into the car metal, and the radio power must be connected directly to the battery.

## Power

The first problem to overcome is connecting the radio directly to the battery, which involves passing the cable directly through the firewall. There are air bag sensors and other sensitive electronics that run through the firewall. Care must be taken to avoid them. The problem is overcome by adding a 7 ah gel cell battery to the radio box. The battery can be charged from the cigarette lighter through a cable, a 1N5404 diode for isolation, and a fuse for protection. The 0.55 volt loss from the diode is negligible. The charger should be unplugged when the radio is in use in order to have complete isolation from the vehicles electrical system. Furthermore, the battery makes the system quick to install and uninstall. The radio used for this project is the Yaesu FT-8900R. Power consumption and estimated battery life is as follows:

<u>Mode</u>	<u>Measured Current Draw</u>	<u>Estimated Battery Life (7 ah battery)</u>
Receive	0.27 amps	25.9 hours
5 Watts Output	2.15 amps	3.26 hours
10 Watts Output	2.86 amps	2.45 hours
20 Watts Output	4.01 amps	1.75 hours
50 Watts Output	7.42 amps	0.94 hours (56 minutes)

The formula for calculating battery life is: Battery life (hours) = Battery Amp Hour / Current

## Antenna and Mount

The second problem to overcome is the antenna. Placement of the antenna can be a problem. Do not place the antenna close to a satellite receiver antenna or a remote start antenna or a navigation GPS antenna, otherwise the output of the transceiver can overload these systems. If a trunk lip mount can be installed easily, there will be little problems with ground coupling. However, if the only other choice is between drilling a hole in the roof or use a magnet mount, use the magnet mount. A

glass mount antenna may also work well. There will be an efficiency loss because of the capacitive ground coupling when using magnet mount or glass mount.

The magnet mount antenna system chosen for this project was the Diamond Antenna MR77. First, two pieces of two inch wide clear adhesive tape was fixed to the bottom of the magnet mount to prevent scratching of the vehicle. One of the problems with using a magnet mount for this project is that the RG58C cable is too thick to fit through the door opening. So, a "C" series Teflon cable was needed. The RG58C cable was cut from the magnet mount. The ends of the remaining 2 inches of RG58C cable were stripped as was the end of a 6.5 foot "C" series Teflon cable, which terminated in an MSA/UHF female connector. The center conductors were soldered together. Then, it was covered with heat shrink tubing. The braids were stretched over the heat shrink tubing. Additional braid was taken from the left over RG58C cable and wrapped around the heat shrink tubing and braids from each end of the cables to completely cover the center insulation. A small amount of solder was made to connect all braids. A 4" length of heat shrink tubing was placed over the entire assembly. After mounting the antenna on a mini van, the SWR was measured as 1.2:1 at 146 MHz. and 1.1:1 at 149 MHz.



MR77



"C" Series cable spliced

## Cabinet and Construction

In the middle of winter, it was doubtful that a power saw outdoors would function well enough to make this a woodworking project. Instead, an off the self plastic case was selected. The battery, radio, mike holder, and components were mounted in the plastic case. The front was cut out leaving extra space for adequate ventilation. Velcro hook strips were added to the bottom. See photos below.

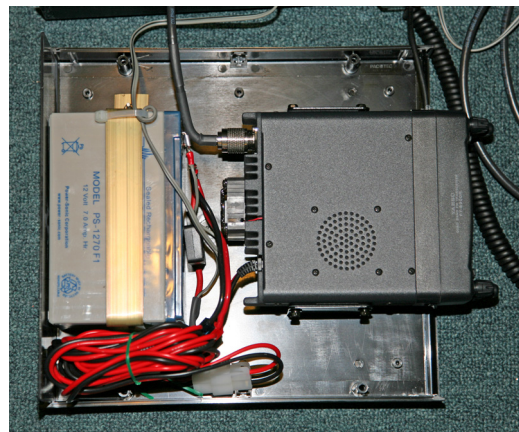



## Parts List

Yaesu FT-8800R, 2m / 70cm, 5-50 watt radio  
Diamond MR77 Dual band magnet mount 19.5" antenna (1/4 wave-2m, 1/2 wave-70cm)  
Power Sonic PS-1270F1, 12 volt, 7.0 AH, sealed gel cell battery  
DM-4-039-K, Plastic Enclosure, 4.38"H x 10.40" W x 11.46" L  
1 inline fuse holder  
Cigarette light plug  
1N5404, 3A Diode  
1 set of Anderson power pole connectors  
2 female disconnects 0.25"  
6-32 x 1/2" screws, lock washers, and nuts as needed

## Second Configuration

The second configuration uses a Kenwood D710 transceiver and a GPS receiver for APRS. The radio is mounted in a plastic case. The radio head, speaker, microphone clip, and GPS receiver are mounted on a wooden board, which is mounted to a cup holder mount.



# Solar Power for Emergency Communications

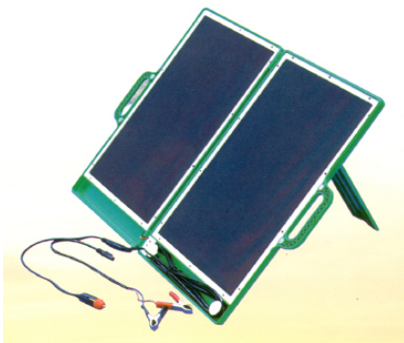

## Introduction

When there is not any electrical power or fuel for an emergency generator, solar (photovoltaic) power is the next best thing. When a solar cell is exposed to light, electron-hole pairs are generated proportional to the intensity of the light. Solar cells are made by bonding p-type and n-type semiconductors. The negatively charged holes move to the p-type semiconductor. They collect at both electrodes to form a potential. When two electrodes are connected to a load, current flows. Amorphous silicon cells have a narrow sensitivity to the visual light spectrum, usually in the infrared region and operate at an efficiency of about 15%. Various configurations of solar cells are being researched such as, multi-junction solar cells. Multi-junction solar cells use several layers of semiconductors. Each layer is sensitive to a specific region of the visual light spectrum, thereby increasing the efficiency of the solar cell conversion to electricity. Multi-junction solar cells are not currently available commercially because the cost is prohibitive. Typically, solar cells have a life expectancy of 40 years.

Two photovoltaic solar panel systems have been evaluated for emergency communications. One is low power, small, lightweight and portable. The other is higher power, heavier, and requires assembly. The "Briefcase" 13 watt solar panel is portable, measuring 20.07" x 14.76" x 1.57", and weighing 12 pounds. The 3 panel 45 watt solar panel is not portable, measuring 36.34" x 36.96", and weighing about 40 pounds. The 3 panel system requires assembly.

Typically solar cells measuring 2 inches by 0.5 inches produce 0.45 volts at 100 milliamps, or 45 milliwatts per square inch. The power generated by the "Briefcase" solar panel is calculated as 296.23 square inches x 45 milliwatts per square inch = 13.3 watts.

Solar Panels don't usually produce enough current to power most devices. Therefore, solar panels are usually used to charge batteries. During daylight, the transceiver draws power from the battery, which is being charged by the solar panel. During nighttime, the transceiver draws power from the battery even though it is not being charged. For 24 hour operation two solar panels and two batteries will be needed. The second solar panel can be used to charge the second battery for use at night. Typically discharging a battery below 50% of its charge will probably damage the battery. Charging 50% of the same battery will require a charge for half the time.

## Power Requirements

The following power supply currents were measured for the Yaesu FT-8900R 29/50/144/430 MHz FM Transceiver while in the 144 MHz FM mode:

<u>Transceiver Mode</u>	<u>Transceiver Current</u>	<u>Watts</u>	<u>50% Battery Runtime (7ah/2=3.5 ah)</u>
Receive	0.27 amps	3.24	12.95 hours
5 Watts Output	2.15 amps	25.8	1.63 hours
10 Watts Output	2.86 amps	34.32	1.23 hours
20 Watts Output	4.01 amps	48.12	0.875 hours (59 minutes)
50 Watts Output	7.42 amps	89.04	0.47 hours (28 minutes)

## 7 Amp Hour Battery for Lightweight Quick Setup Operation



A Power Sonic PS-1270, 12 volt 7 ah, 5.7 pounds, sealed lead acid battery with F1 terminals was used. The 12 volt 7 amp hour battery will require a full charge of 12 volts 7 amps for 1 hour or 12 volts 0.5 amps for 14 hours. Typically discharging a battery below 50% of its charge will probably damage the battery. Charging 50% of the same battery will require a charge for half the time. In this case, it will take 7 hours to charge the battery from 50% to 100% at a charging rate of 0.5 amps. Therefore, a fully charged 12 volt 7 amp hour battery can be used to supply 3.5 amp hours or less and can be recharged in 7 hours. Seven hours of useable daylight is about the most that can be expected in New York.

Amp Hours = Amps x Hours, Watt Hours = Watts x Hours

The 12 volt 18 ah battery will deliver 9 amp hours (50% capacity) of current.

The formula for calculating battery capacity is:

$$\text{Battery Capacity (hours)} = \text{Battery Amp Hour} / \text{Current}$$

When using the Yaesu FT-8900 in receive mode only, the battery will deliver current for 33.33 hours (9 amp hours / 0.27 amps).

If the Yaesu FT-8900 (output of 20 watts) is used in transmit mode for 0.87 hours (52 minutes), it will have used the entire 50% battery capacity of 3.5 amp hours without any current remaining for receive. (0.87 hours = 3.5 amp hours / 4.01 amps)

If the Yaesu FT-8900R (output of 20 watts) is used in transmit mode for 1/2 hour, it will have used 4.01 amps for 1/2 hour or 2.0 amp hours (4.01 amps x 1/2 hour). The remaining 1.5 amp hours will allow the radio to operate in receive mode for 5.55 hours (1.49 amp hours / 0.27 amps).

The Yaesu FT-8900R (output of 20 watts) power consumption and estimated time for 50% of the 7 ah battery (3.5 ah) capacity is:

Current while Transmitting = Transceiver Current (in transmit mode) x hours  
 Current while Receiving = 50% battery capacity – Current while Transmitting  
 Receive time = Current while Receiving / Transceiver Current (in receive mode)

**Calculating Receive Time:**

$$\text{Receive Time} = \frac{50\% \text{ battery capacity} - (\text{Transceiver Current (in transmit mode)} \times \text{hours})}{\text{Current while receiving}}$$

**Calculating Receive Time for the Yaesu FT-8900 (20 watt output) with 7 ah Battery:**

$$\text{Receive Time} = \frac{3.5 \text{ ah} - (4.01 \text{ amps} \times \text{hours})}{0.27 \text{ amps}}$$

<u>Transmit Time</u>	<u>Current while Transmitting</u>	<u>Current while Receiving</u>	<u>Receive Time</u>
0.87 hour (52 min)	3.5 amps	0	0 min
0.5 hours (30 min)	2.00 amps	1.5 amps	5.56 hours
0.25 hours (15 min)	1.00 amps	2.5 amps	9.26 hours
0.125 hours (7.5 min)	0.50 amps	3 amps	11.1 hours

**7 Amp Hour Battery and 13 Watt Solar Panel for Lightweight Quick Setup Operation**

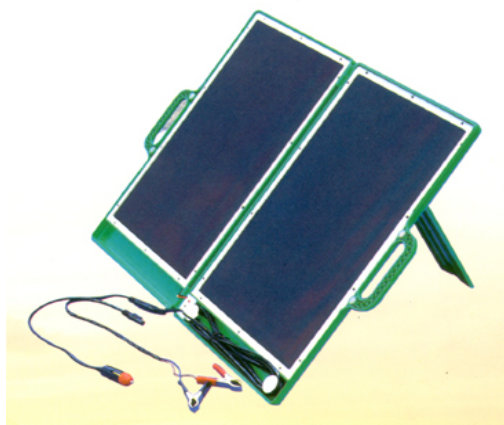

**"Briefcase" Solar Panel Specifications:**

Amorphous silicon solar cells  
 Power: 13 Watts maximum  
 Working voltage: equal or greater than 14 v  
 Working current: equal or greater than 750 ma  
 Dimension and Weight: 20.07" x 14.76" x 1.57", 12 pounds

On a bright sunny April day, 70 degrees F., in Northport, New York, it produced 0.5 amps at 13 volts (6.5 watts) into a 12 volt 7 ah battery with a transceiver connected to the battery. The amount of solar panel power output depends upon the intensity of the sun. To calculate the solar panel output energy produced, 1 watt = 1 joule per second. 6.5 watts = 6.5 joules per second of energy output.

Typically solar cells measuring 2 inches by 0.5 inches produce 0.45 volts at 100 milliamps, or 45 milliwatts per square inch. The power generated by the "Briefcase" solar panel is calculated as 296.23 square inches x 45 milliwatts per square inch = 13.3 watts.

With a solar panel and battery system, drawing less current than the solar panel output will result in surplus current to charge the battery. Drawing more current than the solar panel output will result in drawing current from the battery.

The 12 volt 7 ah battery will deliver 3.5 amp hours of current (50% capacity). The solar panel will deliver (sunny day in New York) 0.5 amp hours of current. The total output of the battery (50% capacity) and solar panel will be 4 amp hours.

When using the Yaesu FT-8900 in receive mode only, the battery while connected to the solar panel will deliver current for 14.8 hours (4 amp hours / 0.27 amps).

If the Yaesu FT-8900 (output of 20 watts) is used in transmit mode for 1 hour, it will have used the entire 50% battery plus solar panel capacity of 4 amp hours without any current remaining for receive. (1 hour = 4 amp hours / 4.01 amps).

If the Yaesu FT-8900R (output of 20 watts) is used in transmit mode for 1/2 hour, it will have used 4.01 amps for 1/2 hour or 2.0 amp hours (4.01 amps x 1/2 hour). The remaining 2.0 amp hours will allow the radio to operate in receive mode for 7.41 hours (2.0 amp hours / 0.27 amps).

The Yaesu FT-8900R (output of 20 watts) power consumption and estimated time for 50% of the 7 ah battery (3.5 ah) capacity plus solar panel output (3.5 amp hours + 0.5 amp hours) is:

Current while Transmitting = Transceiver Current (in transmit mode) x hours  
 Current while Receiving = 50% battery capacity plus solar current – Current while Transmitting  
 Receive time = Current while Receiving / Transceiver Current (in receive mode)

**Calculating Receive Time:**

$$\text{Receive time} = \frac{(50\% \text{ battery capacity} + \text{Solar}) - (\text{Transceiver Current (in transmit mode)} \times \text{hours})}{\text{Current while receiving}}$$

**Calculating Receive Time for the Yaesu FT-8900 (20 watt output) with 7 ah Battery + 13 w Solar:**

$$\text{Receive time} = \frac{4 \text{ ah} - (4.01 \text{ amps} \times \text{hours})}{0.27 \text{ amps}}$$



<u>Transmit Time</u>	<u>Current while Transmitting</u>	<u>Current while Receiving</u>	<u>Receive Time</u>
1 hour (60 min)	4.01 amps	0	0 min
0.5 hours (30 min)	2.00 amps	2.00 amps	7.41 hours
0.25 hours (15 min)	1.00 amps	3.00 amps	11.11 hours
0.125 hours (7.5 min)	0.50 amps	3.5 amps	12.96 hours

## 18 Amp Hour Battery for Higher Power Operation



A Power Sonic PS-12180 NB, 12 volt 18 ah, 12.6 pounds, sealed lead acid battery with nut and bolt terminals was used. The 12 volt 18 amp hour battery will require a full charge of 12 volts 18 amps for 1 hour or 12 volts 2.73 amps for 6.59 hours. Typically discharging a battery below 50% of its charge will probably damage the battery. Charging 50% of the same battery will require a charge for half the time. In this case, it will take 6.59 hours to charge the battery from 50% to 100% at a charging rate of 2.73 amps. Therefore, a fully charged 12 volt 18 amp hour battery can be used to supply 9 amp hours or less and can be recharged in 6.59 hours. Seven hours of useable daylight is about the most that can be expected in New York.

Amp Hours = Amps x Hours, Watt Hours = Watts x Hours

The 12 volt 18 ah battery will deliver 9 amp hours (50% capacity) of current.

The formula for calculating battery capacity is:

$$\text{Battery Capacity (hours)} = \text{Battery Amp Hour} / \text{Current}$$

When using the Yaesu FT-8900 in receive mode only, the battery will deliver current for 33.33 hours (9 amp hours / 0.27 amps).

If the Yaesu FT-8900R (output of 20 watts) is used in transmit mode for 2 hours, it will have used 4.01 amps for 2 hours or 8.02 amp hours (4.01 amps x 2 hours). The remaining 0.98 amp hours will allow the radio to operate in receive mode for 3.63 hours (0.98 amp hours / 0.27 amps).

If the Yaesu FT-8900R (output of 20 watts) is used in transmit mode for 1 hour, it will have used 4.01 amps for 1 hour or 4.01 amp hours (4.01 amps x 1 hour). The remaining 4.99 amp hours will allow the radio to operate in receive mode for 18.48 hours (4.99 amp hours / 0.27 amps).

The Yaesu FT-8900R (output of 20 watts) power consumption and estimated time for 50% of the 18 ah battery (9 ah) capacity is:

Current while Transmitting = Transceiver Current (in transmit mode) x hours

Current while Receiving = 50% battery capacity – Current while Transmitting

Receive time = Current while Receiving / Transceiver Current (in receive mode)

**Calculating Receive Time:**

$$\text{Receive Time} = \frac{50\% \text{ battery capacity} - (\text{Transceiver Current (in transmit mode)} \times \text{hours})}{\text{Current while receiving}}$$

**Calculating Receive Time for the Yaesu FT-8900 (20 watt output) with 18 ah Battery:**

$$\text{Receive Time} = \frac{9 \text{ ah} - (4.01 \text{ amps} \times \text{hours})}{0.27 \text{ amps}}$$

<u>Transmit Time</u>	<u>Current while Transmitting</u>	<u>Current while Receiving</u>	<u>Receive Time</u>
2 hours	8.02 amps	0.98 amps	3.63 hours
1 hour	4.01 amps	4.99 amps	18.48 hours
0.5 hours (30 min)	2.00 amps	7 amps	25.93 hours
0.25 hours (15 min)	1.00 amps	8 amps	29.63 hours
0.125 hours (7.5 min)	0.50 amps	8.5 amps	31.48 hours

**18 Amp Hour Battery and 45 Watt Solar Panel for Higher Power Operation**



**45 Watt Solar Panel System Specifications:**

3 pieces Amorphous silicon solar cells panel (36.34" x 12.32" x 0.75") each

3 x 447.71 square inches = 1,343.13 square inches total

Maximum current, 3000 ma

Power: 15 watts max per panel

Peak voltage: 23.57 volts open current

Weight: 9.7 pounds each panel without the frame (about 40 pounds total)

Charge regulator for 12V, 9V, 6V, 3V outputs, and over charge / discharge / load protection

Typically solar cells measuring 2 inches by 0.5 inches produce 0.45 volts at 100 milliamps, or 45 milliwatts per square inch. The power generated by the 45 watt solar panel system is calculated as 1,343.13 square inches x 45 milliwatts per square inch = 60.44 watts.

A Power Sonic PS-12180 NB, 12 volt 18 ah, 12.6 pounds, sealed lead acid battery with nut and bolt terminals was used.

On a sunny April day, 61 degrees F., in Northport, New York, it produced 2.73 amps at 13.18 volts (35.98 watts) into a 12 volt 18 ah battery with a transceiver connected to the battery. The unloaded voltage measured was 22.68 volts directly from the 3 solar panels connected in parallel. The amount of solar panel power output depends upon the intensity of the sun. To calculate the solar panel output energy produced, 1 watt = 1 joule per second. 35.98 watts = 35.98 joules per second of energy output.

The 12 volt 18 ah battery will deliver 9 amp hours of current (50% capacity). The solar panel will deliver (sunny day in New York) 2.73 amps of current. The total output of the battery (50% capacity) and solar panel will be 11.73 amp hours.

When using the Yaesu FT-8900 in receive mode only, the battery while connected to the solar panel will deliver current for 43.44 hours (11.73 amp hours / 0.27 amps).

If the Yaesu FT-8900 (output of 20 watts) is used in transmit mode for 2 hours, it will have used the 8.02 amps for 2 hours. The remaining 3.71 amp hours will allow the radio to operate in receive mode for 13.74 hours (3.71 amp hours / 0.27 amps).

If the Yaesu FT-8900R (output of 20 watts) is used in transmit mode for 1 hour, it will have used 4.01 amps for 1 hour. The remaining 7.0 amp hours will allow the radio to operate in receive mode for 28.59 hours (7.72 amp hours / 0.27 amps).

The Yaesu FT-8900R (output of 20 watts) power consumption and estimated time for 50% of the 18 ah battery (9 ah) capacity plus solar panel output (9 amp hours + 2.73 amp hours) is:

Current while Transmitting = Transceiver Current (in transmit mode) x hours  
 Current while Receiving = 50% battery capacity plus solar current – Current while Transmitting  
 Receive time = Current while Receiving / Transceiver Current (in receive mode)

**Calculating Receive Time:**

$$\text{Receive time} = \frac{(50\% \text{ battery capacity} + \text{Solar}) - (\text{Transceiver Current (in transmit mode)} \times \text{hours})}{\text{Current while receiving}}$$

**Calculating Receive Time for the Yaesu FT-8900 (20 watt output) with 18 ah Battery + 45 w Solar:**

$$\text{Receive time} = \frac{11.73 \text{ ah} - (4.01 \text{ amps} \times \text{hours})}{0.27 \text{ amps}}$$

<u>Transmit Time</u>	<u>Current while Transmitting</u>	<u>Current while Receiving</u>	<u>Receive Time</u>
2 hours (120 min)	8.02 amps	3.71 amps	13.74 hours
1 hour (60 min)	4.01 amps	7.72 amps	28.59 hours
0.5 hours (30 min)	2.00 amps	9.73 amps	36.04 hours
0.25 hours (15 min)	1.00 amps	10.73 amps	39.74 hours
0.125 hours (7.5 min)	0.50 amps	11.23 amps	41.59 hours

## Summary

### Calculating Receive Time for the Yaesu FT-8900 (20 watt output) with 7 ah Battery:

(5.7 pounds)

<u>Transmit Time</u>	<u>Current while Transmitting</u>	<u>Current while Receiving</u>	<u>Receive Time</u>
0.87 hour (52 min)	3.5 amps	0	0 min
0.5 hours (30 min)	2.00 amps	1.5 amps	5.56 hours
0.25 hours (15 min)	1.00 amps	2.5 amps	9.26 hours
0.125 hours (7.5 min)	0.50 amps	3 amps	11.1 hours

### Calculating Receive Time for the Yaesu FT-8900 (20 watt output) with 7 ah Battery + 13 w Solar:

(17.7 pounds)

<u>Transmit Time</u>	<u>Current while Transmitting</u>	<u>Current while Receiving</u>	<u>Receive Time</u>
1 hour (60 min)	4.01 amps	0	0 min
0.5 hours (30 min)	2.00 amps	2.00 amps	7.41 hours
0.25 hours (15 min)	1.00 amps	3.00 amps	11.11 hours
0.125 hours (7.5 min)	0.50 amps	3.5 amps	12.96 hours

### Calculating Receive Time for the Yaesu FT-8900 (20 watt output) with 18 ah Battery:

(12.6 pounds)

<u>Transmit Time</u>	<u>Current while Transmitting</u>	<u>Current while Receiving</u>	<u>Receive Time</u>
2 hours	8.02 amps	0.98 amps	3.63 hours
1 hour	4.01 amps	4.99 amps	18.48 hours
0.5 hours (30 min)	2.00 amps	7 amps	25.93 hours
0.25 hours (15 min)	1.00 amps	8 amps	29.63 hours
0.125 hours (7.5 min)	0.50 amps	8.5 amps	31.48 hours

### Calculating Receive Time for the Yaesu FT-8900 (20 watt output) with 18 ah Battery + 45 w Solar:

(52.6 pounds)

<u>Transmit Time</u>	<u>Current while Transmitting</u>	<u>Current while Receiving</u>	<u>Receive Time</u>
2 hours (120 min)	8.02 amps	3.71 amps	13.74 hours
1 hour (60 min)	4.01 amps	7.72 amps	28.59 hours
0.5 hours (30 min)	2.00 amps	9.73 amps	36.04 hours
0.25 hours (15 min)	1.00 amps	10.73 amps	39.74 hours
0.125 hours (7.5 min)	0.50 amps	11.23 amps	41.59 hours

The tables above reflect the capacity of the various solar panel systems. The 13 watt solar panel system is lightweight and installed quickly. But, it produces a low current output. The 45 watt solar panel system produces a higher current output. But, it is heavy and requires assembly.

For 24 hour coverage, two solar panel systems will be required. One system can be charging a battery while it is connected to a transceiver during daylight hours. The second solar panel system will be charging a battery for use at nighttime.

The transceiver power output required, the portability of the system required, and the time of operation for a particular event will determine which system should be chosen.

# Lightweight Portable Emergency Communications System



RS10 Light Stand



CRM Mount



AX-75

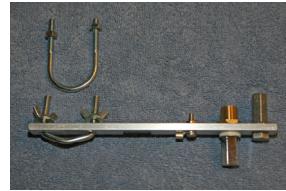

# 901 Dipole Mount



Hamstick



Case

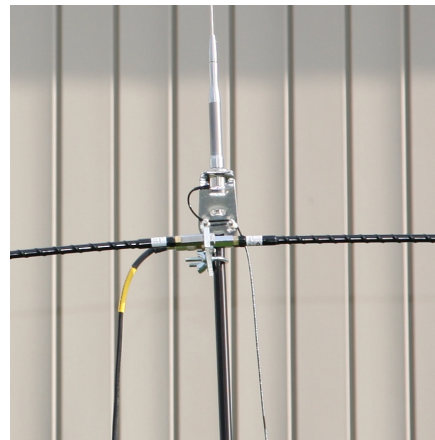

Light Stand with UHF/VHF Vertical Antenna and Horizontal Dipole Hamsticks Antenna

## Introduction

Those who had to carry heavy radio equipment through the subways and around New York City during the Sept 11<sup>th</sup> World Trade Center incident really know the true meaning of "lightweight" and "portable." Often, if something has a handle on it, it is considered portable. However, lightweight is the most important feature when traveling. Unfortunately, high frequency (HF) antennas are usually large and heavy. During personnel recruitment, the type equipment an operator needs to carry should be announced prior to arrival at the incident. During the Sept 11<sup>th</sup> WTC incident, only UHF/VHF equipment has been selected.

For portable use, the smallest, lightest, and the most practical of the antennas and equipment was selected.

## Photographic Light Stand

The Smith-Victor 10 foot aluminum light stand extends to 10 feet high and weighs only 3 pounds. It collapses to 32" and easily fits into a 36" light stand case. The top section has a diameter of 5/8", which is suitable for most mounting clamps. The case is wide enough to accommodate the #901 dipole mount, while permanently mounted to the top section of the light stand.

## UHF/VHF Antenna

The Maldol AX-75 Dual Band Mobile Antenna was selected because it is a 1/2 wave, 30", antenna that will easily fit into the 36" case. The Smith-Victor 10 foot light stand uses plastic connecting parts, which are not conductive. Therefore only the top section will conduct and it will provide the 1/2 wave 19.6" ground plane counterpoise required for UHF/VHF mobile antennas.

## HF Antenna

A dipole hamstick configuration can be used with the Lakeview # 901 dipole mount. The dipole configuration is heavier than the AX-75 antenna and therefore will require guying during moderate to high wind speeds. The Pro Am Valor hamsticks are recommended because they can be tuned prior to use. Then the antenna can be taken apart without tools and without affecting the tuning. The Pro Am Valor is not currently available for 60 meters. Fully assembled, the hamsticks extend to 8 feet long. With two hamsticks in a dipole configuration, there will be a total length of 16 feet. Disassembled, the length of the hamsticks will be 49 inches. Hamsticks come with a plastic carry case. Hamsticks are available in all frequencies including the new 60 meter band (Lakeview brand, which requires a tool).'

The light stand will not provide enough ground plane area for a vertical HF antenna. If a vertical HF antenna is needed, a counterpoise braided cable will be required.

Near Vertical Incident Sky wave (NVIS) is accomplished using horizontal dipole configuration for communications at distances from 200 miles to 800 miles. See the chapter on Antennas for more information about NVIS. A 25 foot or more length of RG8X cable will be required. Hamsticks need to be tuned with an antenna analyzer or bridge.

## AC/DC/UHF/VHF/Packet in a Briefcase



Mount a Yaesu FT-8800R UHF/VHF dual band transceiver, 13 volt, 23 amp switching power supply, Kantronics KPC3 Plus TNC, AC/DC switch, and a 12 volt 7 amp hour sealed lead acid battery, on a 3/4" pine board. The battery, power supply, and TNC are mounted with a Velcro strap. Place the unit into a 6 inch briefcase or tool case. The briefcase unit weighs 22 pounds. To operate packet, a computer will be required. The case can be lightened by 5.7 pounds by removing the battery. Alternately, a Kenwood TMD700 or TMD710 may be used in place of the FT-8800R and Kantronics TNC.

A Power Sonic PS-1270, 12 volt 7 ah, 5.7 pounds, sealed lead acid battery with F1 terminals was used. Typically discharging a battery below 50% of its charge will probably damage the battery. Charging 50% of the same battery will require a charge for half the time.

**Power Consumption:**

<u>Transceiver Mode</u>	<u>Transceiver Current</u>	<u>Watts</u>	<u>50% Battery Runtime (7ah/2=3.5 ah)</u>
Receive	0.27 amps	3.24	12.95 hours
5 Watts Output	2.15 amps	25.8	1.63 hours
10 Watts Output	2.86 amps	34.32	1.23 hours
20 Watts Output	4.01 amps	48.12	0.875 hours (59 minutes)
50 Watts Output	7.42 amps	89.04	0.47 hours (28 minutes)

**Transmit / Receive Times:**

<u>Transmit Time</u>	<u>Current while Transmitting</u>	<u>Current while Receiving</u>	<u>Receive Time</u>
0.87 hour (52 min)	3.5 amps	0	0 min
0.5 hours (30 min)	2.00 amps	1.5 amps	5.56 hours
0.25 hours (15 min)	1.00 amps	2.5 amps	9.26 hours
0.125 hours (7.5 min)	0.50 amps	3 amps	11.1 hours

Amp Hours = Amps x Hours, Watt Hours = Watts x Hours

**HF Transceiver**



There are a number of great HF transceivers. However, if 60 meters communications is desired, the Yaesu FT-897D or FT-857D will perform well. The only difference between the two is that the FT-857 is made for 12 volts DC only. The FT-897 can be used with a 12 volt DC input, internal batteries, or AC power supply. The auto tuner was attached to the radio tested. The HF radio will require a Power Sonic PS-12180 NB, 18 amp hour battery. Hamsticks are available for 60 meters.



**VHF Power Consumption:**

<u>Transceiver Mode</u>	<u>Transceiver Current</u>	<u>Watts</u>	<u>50% Battery Runtime (18ah/2=9 ah)</u>
Receive	0.91 amps	10.92	9.89 hours
5 Watts Output	3.28 amps	39.36	2.74 hours
10 Watts Output	4.12 amps	49.44	2.18 hours
20 Watts Output	5.79 amps	69.48	1.55 hours
50 Watts Output	9.74 amps	116.88	0.92 hours (55 minutes)

**VHF Transmit 20 watts / Receive Times:**

<u>Transmit Time</u>	<u>Current while Transmitting</u>	<u>Current while Receiving</u>	<u>Receive Time</u>
1.55 hours	9.00 amps	0	0 min
1 hour	5.79 amps	3.21 amps	3.53 hours
0.5 hours (30 min)	2.90 amps	6.1 amps	6.70 hours
0.25 hours (15 min)	1.45 amps	7.55 amps	8.30 hours
0.125 hours (7.5 min)	0.725 amps	8.28 amps	9.10 hours

**HF (14.2 MHz) Power Consumption:**

<u>Transceiver Mode</u>	<u>Transceiver Current</u>	<u>Watts</u>	<u>50% Battery Runtime (18ah/2=9 ah)</u>
Receive	0.91 amps	10.92	9.89 hours
5 Watts Output	4.15 amps	49.80	2.17 hours
10 Watts Output	5.32 amps	63.84	1.69 hours
20 Watts Output	6.59 amps	79.08	1.37 hours
50 Watts Output	10.32 amps	123.84	0.87 hours (52 minutes)
75 Watts Output	12.26 amps	147.12	0.73 hours (44 minutes)
100 Watts Output	16.10 amps	193.20	0.56 hours (34 minutes)

**HF (14.2 MHz) Transmit 20 watts / Receive Times:**

<u>Transmit Time</u>	<u>Current while Transmitting</u>	<u>Current while Receiving</u>	<u>Receive Time</u>
1.37 hours	9.00 amps	0	0 min
1 hour	6.59 amps	2.41 amps	2.65 hours
0.5 hours (30 min)	3.30 amps	5.70 amps	6.26 hours
0.25 hours (15 min)	1.65 amps	7.35 amps	8.08 hours
0.125 hours (7.5 min)	0.82 amps	8.18 amps	8.99 hours

**Parts List**

- Yaesu FT-8800R UHF/VHF Transceiver - \$375
- Yaesu FT-897D UHF/VHF/HF Transceiver - \$800
- Yaesu FP-30, 110-220V Internal Power Supply for the FT-897D - \$220
- Yaesu FC-30 Antenna tuner that bolts onto the side of the FT-897D - \$200
- Kantronics KPC3 plus TNC - \$190
- Samlex SEC-1223 23 amp switching power supply - \$99
- Power Sonic PS-1270, 12 volt, 7 amp hour sealed acid battery - \$20
- Power Sonic PS-12180 NB, 12 volt, 18 amp hour sealed acid battery - \$52

Smith-Victor, RS10, 10 ft. Aluminum Light Stand, Folds to: 32 in., Footprint: 47 in., Weight: 3.0 lbs. - \$45

Davis & Sanford, DATC Tribag, 36", Padded Tripod Case - \$20

Diamond, C211, SO239 mount with RG8X extension cable for 16.5 feet total - \$50

Diamond, CRM, Right Angle Bracket with U Bolts - \$17

Maldol, AX-75 2m/70 cm, 1/2 wave, Dual Band Mobile Antenna, 30" - \$60

Two Pro Am, Valor PHF20, Valor 20 meter 8', 3/8-24 whips (1/4 wavelength) - \$24

Two Pro Am, Valor PHF40, Valor 40 meter 8', 3/8-24 whips (1/4 wavelength) - \$24

Two Pro Am, Valor PHF80, Valor 80 meter 8', 3/8-24 whips (1/4 wavelength) - \$24

Two Lakeview, Hamstick, 9160, 60 meter 8', 3/8-24 whips (1/4 wavelength) (tools required) - \$30

Lakeview, # 901, dipole mount - \$19 + 3/8-24 5/8" bolt, 1-1/8" spacer, 3/8" washer, shorter u-bolt

Two (one for UHF/VHF and one for HF) Cable Xperts, CXP08XC25, 25 FT RG8X CABLE W PL259S - \$26

6" tool case - \$20 from Home Depot

Reliance Best Power Peg Plastic Stakes-12 inch, [www.campmor.com](http://www.campmor.com), Item Number: 21768, 6/\$3.99

Tent Mallet, [www.campmor.com](http://www.campmor.com), Item Number: 26006, \$3.99

1/8" nylon cord for guying

Above prices effective as of 5/2/07

# Part 3

# Emergency Preparedness

# Emergency Preparedness

Excerpts from FEMA Independent Study Course IS-2 "Emergency Preparedness U.S.A."

## 1. The Four Phases of Emergency Management

1. Preparedness – Preparing to handle an emergency  
Plans or preparations to save lives and to help response and rescue operations.
2. Response – Responding safely to an emergency  
Actions taken to save lives and prevent further property damage in a disaster or emergency situation
3. Recovery – Recovering from an emergency  
Actions taken to return to a normal or even safer situation following an emergency
4. Mitigation – Preventing future emergencies or minimizing their effects.  
Any activities that prevent an emergency, reduce the chance of an emergency happening, or reduce the damaging effects of unavoidable emergencies.

## 2. Analyzing the Risks

Determining Local Hazards

- Your community's past history of emergencies caused by the hazard,
- Geographical considerations,
- Community characteristics, and
- Distance from transportation routes, large urban areas, large industrial areas, or military bases.

The Major Natural Hazards

### ● Severe Thunderstorm

Severe thunderstorms are weather systems accompanied by strong winds, lightning, heavy rain or hail, and possibly tornados.

Every State – Southeast and Midwest have the greatest frequency. Florida has the greatest occurrence

### ● Flood and Flash Flood

A flood occurs when a river or stream overflows its bed onto normally dry land. Floods can be slow to develop, or in the case of flash floods, they can occur suddenly with devastating power.

Every State

### ● Landslide and Mudflow

A landslide is a the movement of unstable soil and rocks down the side of a slope.

Every State – Major landslides occur along the West Coast, the western slope of the Rockies, the central Mississippi Valley, and the Appalachian Region.

- **Tornado**

Tornados are extremely violent localized windstorms. A tornado is characterized by a funnel cloud that reaches to the ground with wind velocities inside the funnel as high as 200 miles per hour. Tornados are formed by violent thunderstorms and hurricanes. They appear as a vertical funnel cloud reaching to the ground, and creating an incredibly loud roar. Tornados almost always travel from the southwest to the northeast.

Every State – More frequent in the Midwest, Southeast, and Southwest. The states of Mississippi, Kansas, Arkansas, Oklahoma, Illinois, Indiana, Iowa, Missouri, Nebraska, Texas, Louisiana, Florida, Georgia, Alabama, and South Dakota are at greatest risk.

- **Hurricane**

Hurricanes are severe tropical storms that spiral around a calm center known as the eye. Wind speeds range from 74 miles per hour to a high of 220 miles per hour. As hurricanes approach land, they create a storm surge along the coastline that raises water several feet above high tide levels. Hurricanes also dump heavy rains and cause flooding as they travel inland.

Vulnerable areas in the United States include the territories in the Caribbean, the coast from Texas to Maine, and tropical areas of the western Pacific Ocean, including Hawaii.

- **Winter Storm**

Winter storms vary in size and intensity and may affect a small part of one State or several States at once. Winter storms may be categorized as ice storms, heavy snowfall, or blizzards.

Almost all of the United States, except Hawaii and the Territories are at risk.

- **Drought and Extreme Heat**

A drought is an extended period of unusually dry weather. Droughts become severe if several months pass without significant precipitation.

Extreme heat is defined as temperatures that are 10 or more degrees above the average temperature, and that last for several weeks during the hottest time of the year.

Anywhere in the United States.

- **Wildfire**

Wildfire is any instance of uncontrolled burning in grasslands, brush, or woodlands. Wildfires can be caused by lightning, human carelessness, or arson. Wildfires can occur in all wooded, brush, and grassy areas, especially those in Kansas, Mississippi, Louisiana, Georgia, Florida, the Carolinas, Tennessee, California, Massachusetts, and the national forests in the western States.

- **Earthquake**

An earthquake is a trembling of the ground that results from the sudden shifting of rock beneath the earth's crust. Earthquakes can occur along fault lines where massive plates of rock located beneath the Earth's crust move against one another. Earthquakes have occurred in most areas of the United States. The most frequent earthquake events occur States west of the Rocky Mountains, although

historically the most violent Earthquakes have occurred in the Eastern United States and in the Central Mississippi Valley. California is especially vulnerable because of its high Seismic activity. Other highly vulnerable areas are Charleston, South Carolina, and the central United States (the New Madrid Seismic Zone), both of which were devastated by earthquakes in the last century.

- **Tsunami**

A tsunami is a series of giant sea waves. These are generated by earthquake or Volcanic action on the ocean floor or near coastal areas. Tsunami waves can travel more than 500 miles per hour through open seas and build to heights of 100 feet or more when approaching the shoreline. Tsunamis have occurred mainly in the Pacific. However, it is possible for a tsunami to occur along any coastline.

- **Volcanic Eruption**

A volcano is an eruption from the earth's interior. The material coming from the eruption may be in the form of slow lava flow, or an explosive blast of powdered rock, steam, and other gases. The primary areas affected include the Pacific Rim States of Hawaii, Alaska, Washington, Oregon, and California. Montana and Wyoming also are at risk, but to a lesser extent.

- **Dam Failure**

The failure of dams due to excessive rainfall, volcanic eruption, poor construction, poor maintenance, or earthquake activity can cause catastrophic floods. States; more than 20,000 are classified as posing "high" or "significant" hazards. These designations mean that if such a dam failed, lives could be lost and extensive property damage would be suffered.

## **Hazardous Materials**

Areas at risk would be along highways, rail lines, pipelines, rivers, and port areas. Because major highways run through virtually all local jurisdictions, all sections of the country are at risk.

## **Radiological Materials**

Dangers posed by radioactive wastes are concentrated in the immediate vicinity of the Disposal sites or along transportation routes. Disposal sites are located in remote areas or at nuclear power facilities.

## **Structural Fire and Explosion**

Accidental structural fire and explosion can strike anywhere. Though arson once was confined to major urban areas, it now can occur in practically any community in the United States.

### 3. Natural Hazards: Applying the Four Phases

#### SEVERE THUNDERSTORMS

##### SIGNS AND WARNINGS

Lightning, thunder, and storm clouds occur together. Dark, towering, or threatening clouds are the first indication of possible thunderstorms. Distant lightning and thunder is another sign. Because light travels so much faster than sound, lightning flashes can be seen long before the resulting thunder is heard. To estimate how many miles away a thunderstorm is from your area, count the number of seconds between a flash of lightning and the next clap of thunder, and then divide by five. For example, if there are 10 seconds between the lightning flash and thunder, the storm is two miles away (10 seconds divided by five).

Because thunderstorms may occur singly, in clusters, or in lines, it is possible that several thunderstorms may affect you in the course of a few hours.

The National Severe Storms Forecast Center in Kansas City, Missouri, issues severe thunderstorm watches. Local National Weather Service offices issue warnings and statements about severe weather and localized storms.

A severe thunderstorm watch means that conditions are right for lightning and/or damaging winds greater than 58 miles per hour, hail that could reach a diameter of three quarters of an inch, and heavy rain.

A severe thunderstorm warning means that severe thunderstorms have been sighted in your area.

##### IMMEDIATE DANGERS

Sudden strong winds often accompany a thunderstorm and may blow down trees across roads and power lines. In a severe thunderstorm the winds can cause extensive damage to roof and windows and may tip over mobile homes.

Lightning presents the greatest immediate danger during a thunderstorm. In an average year lightning kills more people in the United States than the number of persons killed from tornados, floods, and hurricanes combined.

Flash floods and tornados can develop during thunderstorms

Hail can severely damage agricultural crops.

##### LONG-TERM DANGERS

One or more severe thunderstorms occurring over a period of less than a week can cause extensive power outages, agricultural damage, and may lead to flooding.

## MITIGATION

Install lightning rods on all high-risk buildings. Lightning rods will carry the dangerous electrical charge of lightning bolts safely to the ground.

Crops can be insured against loss from storm damage through the Federal Crop Insurance Corporation of the U.S. Department of Agriculture.

Support the adoption and enforcement of a floodplain management ordinance.

Buy flood insurance through your local property insurance agent.

## PREPAREDNESS

If you plan to be outdoors, check the latest weather forecast and keep a weather eye on the sky. When you observe signs of an impending storm—towering thunderheads, darkening skies, lightning, increasing wind - tune in your NOAA Weather Radio, AM-FM radio, or television for the latest weather information.

If you live in a mobile home, you should make sure that it has been securely tied down to a solid foundation or ground anchors to keep the wind from shifting it or turning it over.

Designate a safe area in or near your home to shelter your family in a severe thunderstorm.

Teach all family members to pay attention to storm warnings and educate them on what to do in a storm if they are at home, outside, or in a car.

Stock your shelter with candles or flashlights and with a battery-powered radio to listen to weather reports.

## RESPONSE

Do not stay in a mobile home during a severe thunderstorm.

Get inside a storm shelter, home or large building, or inside a vehicle (but not a convertible).

If you are inside a home, avoid using the telephone except for emergencies.

If you are outside and do not have time to reach a safe building or an automobile follow these rules:

- Do not stand underneath a natural lightning rod such as a tall, isolated tree in an open area.
- Get out of and away from open water.



- Get away from tractors and other metal farm equipment.
- Get off of and away from motorcycles, scooters, golf carts, and bicycles. Put down golf clubs.
- Stay away from wire fences, clotheslines, metal pipes, rails, and other metallic paths that could carry lightning to you from some distance away.
- In a forest, seek shelter in a low area under a thick growth of small trees. In open areas, go to a low place such as a ravine or valley, but remain alert for flash floods.
- If you are isolated in a level field or prairie and you feel your hair stand on end (which shows that lightning is about to strike), drop to your knees and bend forward, putting your hands on your knees. Do not lie flat on the ground.

If you are in a car, pull safely on to the shoulder and turn on your emergency flashers until the heavy rain subsides.

A person struck by lightning will receive severe electrical shock and may be burned; however, the individual will carry no electrical charge and can be handled safely. Give first aid and call emergency medical assistance immediately.

- If a victim is not breathing, mouth-to-mouth resuscitation should be given immediately to prevent permanent brain damage.
- Victims who appear only stunned or otherwise unhurt may also need attention. Check for burns, especially at fingers and toes and next to buckles and jewelry.

More than one storm may strike an area within a few hours. Once one storm subsides, be certain there are no more storms approaching before resuming your normal activity.

## RECOVERY

Have damage to your home and property assessed as required by your property insurance company. Clean up and repair damage as soon as authorized by your insurer.

## RELATED EMERGENCIES

Keep in mind that thunderstorms can cause other major natural hazards. Tornadoes and flash floods may be caused by severe storms. Also, lightning is a major cause of wildfires. Thunderstorms originate in clouds called "thunderheads" which form in warm, moist air as it rises above cold air.

## FLOOD AND FLASH FLOOD

### SIGNS AND WARNINGS

Floods and flash floods almost always occur during or after a period of heavy rain or sudden snowmelt. A flood may be building in your area when you notice local streams and rivers flowing more swiftly and at a noticeably higher level than normal.

Many communities have installed water gauges to help monitor water levels.

Flood warnings are issued by the National Weather Service. Local police, the sheriff, the highway patrol, the county flood control district office, and other local agencies may also supply flood warnings.

- A flash flood watch is issued when flash flooding is possible within the designated watch area; be alert.
- A flash flood warning is issued when a flash flood has been reported or is imminent: take necessary precautions.
- A flood warning is issued as an advance notice that a flood is imminent or is in progress at a certain location or in a certain river basin. Take precautions as directed.

### IMMEDIATE DANGERS

The immediate danger from flash floods is from the strength of the water current as it surges through an area, carrying debris and causing injuries and drowning.

Floods can interrupt power, disable fuel sources, and make roads impassable. People may be stranded in their homes, or be unable to reach their homes.

### LONG-TERM DANGERS

Dangers include the outbreak of disease, widespread animal death, broken sewage lines and widespread water supply pollution, broken gas lines, downed power lines and fires.

Large-scale flooding can disrupt a community for a long time while utilities are restored, debris is cleared, and property is repaired.

Agricultural lands can be ruined and crops destroyed by flooding.

### MITIGATION

Through the National Flood Insurance Program (NFIP), people can protect themselves from financial ruin due to property loss from floods. Ask your local property insurance agency about flood insurance.

Avoid building in a flood plain unless you elevate and reinforce your home. Check local building codes and ordinances. While the cost of protecting your home may be expensive, the investment will save you from the potential of even costlier damage. Remember, the cherished possessions of a lifetime cannot be replaced by money.

## PREPAREDNESS

Stockpile emergency building materials such as sandbags, plywood, plastic sheeting, and lumber.

Install check valves in building sewer traps to prevent flood water from backing up in sewer drains.

Keep your car fueled. If electric power is disrupted, gas station pumps maybe out of operation for several days.

Make family evacuation plans. If you are in a flash flood area, have several alternate routes to ensure rapid evacuation.

Maintain emergency supplies such as a first aid kit, water, and foods that require little or no cooking and no refrigeration. A portable radio, emergency cooking equipment, and flashlights should all be maintained in a designated area.

Store drinking water in jugs, bottles, and pans.

## RESPONSE

As flood waters rise, take these key precautions:

- Secure all outdoor items or store them inside on upper levels.
- Move all valuable household possessions to upper levels away from rising floods.
- Move cars, machinery, and all livestock to higher ground.
- Check emergency food and water supplies—keep them high and dry.

Listen to radio announcements from emergency officials. If you are told to evacuate, do so immediately. Use only those routes recommended by local authorities. Any other route could be blocked or otherwise made impassable by flooding.

If there is time before evacuation turn off all utilities at the main switch. Do not touch any electrical equipment unless it is in a dry area, or you are well insulated with rubber footwear and gloves.

Do not attempt to drive over a flooded road; you can become stranded or trapped. If your car stalls while in flowing water, abandon it immediately. Cars may only serve as traps in the face of a raging flood.

Do not attempt to cross a flowing stream where water is above your knees.

In a flash flood warning, the only thing to do is move immediately to high ground. Because of the speed with which a flash flood travels, you have no time to save any possessions or implement any precautionary measures. Save your life by moving to high ground without any hesitation.

## RECOVERY

If your home, apartment, or business has been damaged and you have a flood insurance policy, immediately call your property insurance agent for advice on what you should do next to receive assistance.

Do not use fresh food that has come in contact with flood waters. Have all drinking water tested by local health authorities before using. Wells should be pumped out and the water tested before drinking.

Before entering a building, check for structural damage; make sure it is not in danger of collapsing.

Open the building and let it air out for several minutes before entering to remove foul odors or escaped gas.

Upon entering the building, do not use a match or lantern as a source of light because of the possibility of gas buildup; a battery powered flashlight is recommended. Check for electrical shorts and live wires. Make certain the power is turned off and do not use any appliances or lights until an electrician has checked your electrical system.

Report broken utility lines to appropriate authorities.

Open all doors and windows to help dry the building. Shovel out mud while it is still moist to give walls and floors an opportunity to dry.

## RELATED EMERGENCIES

Keep in mind that floods can cause landslides, mudflows, and power outages.

## LANDSLIDE AND MUDFLOW

### SIGNS AND WARNINGS

Landslide warning signs include opening of cracks on hill slopes—evidence of slow, downhill movement of rock and soil; tilting of trees, poles, or walls; or perceptible changes such as the formation of sags and bumps in the slope.

Mudflows are most commonly triggered by high-intensity rainstorms, but can also occur following forest fires when soil is newly bare. They tend to flow in channels, but will often spread out over the flood plain. They generally occur in places where they have occurred before.

If you suspect a slope is unstable, have a specialist examine the slope. Possible signs of slope failure include the following:

- Doors or windows sticking or jamming for the first time;
- New cracks appearing in plaster, tile, brick, or foundations;
- Outside walls, walks, or stairs beginning to pull away from the building;
- Slowly developing, widening cracks appearing on the ground or on paved
- Underground utility lines breaking;
- Fences, retaining walls, utility poles, or trees tilting or moving; and/or
- Water or bulging ground appearing at the base of a slope.

### IMMEDIATE DANGERS

Immediate dangers from landslides or mudflows include injuries, fatalities, and destruction of property as rocks, mud, and water slide downhill or downstream.

### LONG-TERM DANGERS

Long-term, slow-moving landslides destroy many structures each year by gradual downhill movement. Once such movement begins it is very difficult to control.

Associated dangers include broken electrical, water, gas, and sewage lines. Fires also may be started by damaged electrical wires and gas lines.

Other long-term dangers from this hazard include the continued threat of landslides due to unstable land. Erosion from the loss of adequate ground cover could be very damaging and lead to flash flooding during periods of heavy rain or following heavy snows.

## MITIGATION

Before buying land or building on any property, check with the county land commissioner or with the local office of the U.S. Geological Survey for ground composition, drainage, and stability.

Plant groundcover on slopes, or build retaining walls.

Reinforce the foundation and walls of your home.

Install flexible rather than stiff pipe fittings to avoid gas or water leaks in the event of a landslide or mudflow.

In mudflow areas, construct channels or reinforced masonry walls to direct the mudflows around your home or buildings.

Mudflow is covered by flood insurance policies from the National Flood Insurance Program. Buy flood insurance through your local property insurance agent.

## PREPAREDNESS

Be prepared to evacuate your home.

## RESPONSE

If you are warned of an impending landslide or mudflow, evacuate at once to stable ground.

If you are inside a building during a landslide, stay inside and get under a desk, table, or other piece of sturdy furniture.

If you are outside and cannot get into a sturdy building while scattered rocks and debris tumble toward you, curl into a tight ball and protect your head.

Usually, you can survive a mudflow only by avoiding it. If you are in a valley, get out as soon as possible once you hear rumbling from upstream or feel the ground tremble. These are signs that a mudflow may be coming your way.

## RECOVERY

If a landslide or mudflow has occurred near your home, thoroughly check the

Check for damaged gas, electrical, or waterlines. Do not strike a match or attempt to turn on electricity until you are sure it is safe. Report damages to the appropriate utility companies.

Stabilization of new land should take place as quickly as possible to reinforce against secondary slippage.

Replanting damaged land will help tremendously in both short- and long-term

## TORNADO

### SIGNS AND WARNINGS

Tornados develop during severe thunderstorms and hurricanes. While not all thunderstorms and hurricanes create tornados, the potential is there. During violent weather, keep tuned to a local television or radio station for tornado reports.

If you are outside and see a funnel-shaped cloud with obvious rotating motion, it may be a tornado. As a tornado develops, it will produce a loud roar that grows louder as the funnel cloud touches the ground. When nearby, a tornado has a loud sound comparable to the combined roars of several jet engines.

The National Severe Storms Forecast Center in Kansas City, Missouri, issues tornado watches. Local National Weather Service offices issue tornado warnings. Local officials may sound sirens in a tornado warning.

- A tornado watch indicates that conditions are right for a tornado to develop and that the sky should be watched.

- A tornado warning indicates a tornado has been sighted or is spotted on radar. Warnings will give the location of the tornado and the area immediately affected by the warning.

### IMMEDIATE DANGERS

The immediate threat from tornados is danger to life and damage to property from violently whirling winds and debris hurled through the air by the winds.

### LONG-TERM DANGERS

Long-term risks include the possibility of building collapse, fallen trees and power lines, broken gas lines, broken sewer and water mains, and the outbreak of fires. Agriculture, crops, and, industries may be damaged or destroyed.

### MITIGATION

Follow relevant building code practices such as the use of wind-resistant design.

### PREPAREDNESS

The best preparation for a tornado is to designate a safe place in or around your home as a tornado shelter. Tornado shelters are safest if they are underground.

A storm cellar or basement away from windows offers the best protection.

If neither of these is available, plan to find shelter under heavy furniture or mattresses near an inside wall of your house on the ground floor. Get under solid

furniture or cover yourself with mattresses pulled off the bed.

Plan tornado drills with your family so everyone knows what to do.

Know the location of the designated shelter where you work or go to school.

Plan to evacuate your manufactured (mobile) home.

Make an inventory of your household furnishings and other possessions. Supplement the written inventory with photographs or video. Keep inventories and pictures in a safe deposit box or some other safe place away from the premises.

## RESPONSE

If you have a storm cellar or shelter, go to it immediately with your family. If no shelter is available, go to your basement and get under a heavy workbench or stairs. Do not position yourself directly underneath heavy appliances on the floor above you.

If your home has no basement, stay in the center of the house away from the windows or in a small room on the ground floor that is away from outside walls. Take cover under solid furniture or mattresses. Protect your head.

In mobile homes or vehicles, leave and take shelter in a substantial structure. If there is no nearby shelter, lie flat in the nearest ditch or ravine with your hands shielding your head.

In any large building, such as an office or a department store, avoid all large, poorly supported roofs. Go to the basement or to an inner hallway on a lower floor.

Do not drive. You are safer in a home or basement shelter than in a car.

If you are driving in a city and spot a tornado, get out of your car and go in to a nearby building.

If you are driving in open country, drive at a right angle away from the tornado's path if you can safely do so. Do not try to outrun the storm. If you cannot avoid the tornado, get out of your car. Lie flat in the nearest depression, such as a ditch, culvert, or ravine. Protect your head, and stay low to the ground.

## RECOVERY

After a tornado passes, keep tuned to the local radio or TV station to get an all-clear signal before leaving your shelter. Sometimes more than one tornado will develop during a violent storm.

Re-enter buildings with extreme caution.



Be alert to fire hazards such as broken electrical wires or damaged electrical equipment, gas or oil leaks, or smoldering piles of wet hay or feed. Report broken utility lines to the appropriate authorities.

Have damage to your property assessed by your insurance company.

### **RELATED EMERGENCIES**

Tornados are part of a severe thunderstorm and bring with them the dangers of lightning, high winds, floods, and flash floods from extremely heavy rainfall.

## HURRICANE

### SIGNS AND WARNINGS

As a hurricane approaches, the skies will gradually darken over the ocean or gulf, and winds will continue to grow in velocity. The barometric pressure will fall, winds will increase, and rain will fall in torrents.

The National Hurricane Center in Miami monitors weather data and will issue forecasts for hurricanes in the Atlantic Ocean, Caribbean Sea, Gulf of Mexico, and the eastern Pacific Ocean. Your local National Weather Service office, as well as local and State officials, may disseminate hurricane information.

Learn the terminology used to convey hurricane emergency information.

- A hurricane advisory tells where the storm is located, the intensity of wind speeds, and the direction of movement.
- A hurricane watch is issued for a coastal area when there is a threat of hurricane conditions within 24 to 36 hours. In some more vulnerable areas, actions for protection of life and property should begin at this point.
- A hurricane warning is issued when hurricane conditions are expected in a specified coastal area in 24 hours or less. Hurricane conditions include winds of 74 miles an hour (64 knots) and/or dangerously high tides and waves. Final actions for protection of life and property should be completed as quickly as possible before high winds and heavy rains arrive.

### IMMEDIATE DANGERS

The storm surge can destroy property along a coastline and is the major threat to life. Dangers associated with a hurricane emergency include extremely high winds that can demolish houses, uproot trees, and fill the air with debris. Tornados may develop as a hurricane passes.

### LONG-TERM DANGERS

Long-Term hazards come in the form of interrupted gas, water, and electric power, fires and explosions from gas leaks, fallen power lines, electrical short circuits, and contaminated food and water.

### MITIGATION

Retrofit your home to withstand wind and flooding. Coastal homes in flood hazard areas should be elevated. All windows should be shuttered, and structural connectors reinforced. Un-reinforced masonry should be strengthened. Consult FEMA's Coastal Construction Manual (FEMA-55) for guidance (see page R-1).

Support the adoption and enforcement of floodplain management requirements.

In addition to your property insurance, buy a flood insurance policy from your insurance agent. Renters also can buy a flood policy for personal property.

## PREPAREDNESS

Learn about hurricanes - the warnings, the dangers, and how to protect your property, your family, and yourself.

Be prepared as each hurricane season begins. Every June, recheck your window shutters and supply of boards, tools, batteries, nonperishable foods, bottled water, and other equipment needed to ensure your safety.

Plan a flood-free evacuation route if your area is vulnerable to flooding or if you live in a mobile home.

Make a household inventory with pictures or a video and keep it with your insurance policies in a safe place such as a safety deposit box.

## RESPONSE

When your area receives a hurricane watch, keep calm; plan your time before the storm arrives and avoid a last-minute rush that might leave you marooned or unprepared. Take the following precautions.

- Listen for weather updates.
- Moor your boat securely, or move it to a designated safe area.
- Board up your windows, or protect them with shutters or tape to reduce danger from wind-driven debris and high wind pressure.
- Secure outdoor objects such as tools, porch furniture, garbage cans, and bicycles that could become deadly projectiles in, hurricane winds. Store them inside if possible.
- Store drinking water in clean bathtubs; bottles; and pans. Ensure batteries are fresh and in sufficient quantity.
- Keep your car's gas tank filled during a hurricane watch. Service stations may be closed for several days after a hurricane, due to power outages and flooding.

Manufactured (mobile) homes are extremely susceptible to high winds and should be evacuated for more substantial shelter.

Evacuate low-lying areas when ordered by officials, and turn off utilities at the

main switch, if time permits.

Stay at home only if it is safe to do so. If you are advised to evacuate, follow directions of local officials.

When a hurricane strikes, stay indoors away from windows.

Travel is extremely dangerous during high winds and storm surges. Do not attempt to travel by car or foot once high winds reach your area.

If the storm center passes directly overhead, the wind will calm down to a period lasting from a few minutes to half an hour or more. Do not be fooled into thinking the hurricane has passed while the eye is over your area. Many people lose their lives by making this mistake. When the winds begin again, they will grow rapidly to hurricane force, and come from the opposite direction.

Severe flooding may follow hurricanes as they move inland. Stay away from river banks and streams. Monitor National Weather Service advisories on flood stages.

## RECOVERY

If you evacuated; return home when authorities tell you it is safe. Before entering, be sure the structure is safe to enter.

Call your insurance agent and take pictures of damage to your house and its contents. Hose down hard goods such as major appliances and furniture, even if they are destroyed. You need to keep these for the adjuster's inspection. The adjuster will help you make decisions on whether to repair possessions or replace them.

Throw out perishable or water-contaminated foods.

Avoid loose or dangling wires, and report them to the power company.

Report broken sewer or water mains to the water department.

Check for gas leaks, and do not strike a match or relight appliances until they have been inspected.

Open windows and doors to let the air circulate. This will help remove foul odors and protect you from escaping gas. It also will help dry out the house.

Pump out the basement if it is flooded, but do it gradually. Drain one-third of the flood water each day, to minimize further structure damage. Shovel out the mud while it is still moist, and dry rugs and carpets thoroughly.

Make any temporary repairs necessary to prevent further losses.

Assure that substantially damaged structures are elevated above the base flood

elevation when reconstructed.

### **RELATED EMERGENCIES**

Hurricanes can be accompanied by other severe storm hazards such as lightning, tornados, and flooding.

## WINTER STORM

### SIGNS AND WARNINGS

The National Weather Service issues watches and warnings for hazardous winter weather. Keep informed by listening to weather forecasts on radio or TV and reading local newspapers. Know the terms used to describe storm status.

- Winter storm watch	Severe winter weather may affect your area.
- Winter storm warning	Severe winter weather conditions are expected.
- Ice storm warning	Significant, possibly damaging, ice accumulation is expected.
- Heavy snow warning	A snowfall of at least four inches in 12 hours or six inches in 24 hours is expected.
- Blizzard warning	Large amounts of falling or blowing snow and winds of at least 35 miles per hour are expected for several hours.
- Severe blizzard warning	Considerable falling or blowing snow, winds of at least 45 miles per hour, and temperatures of 10 degrees Fahrenheit or lower are expected for several hours.
- High wind warning	Winds of at least 40 miles per hour are expected to last at least one hour.
- Travelers' advisory	Ice and snow are expected to hinder travel, but the anticipated weather conditions are not serious enough to require warnings.

### IMMEDIATE DANGERS

Heavy snowfall and blizzards can trap motorists in their cars, cause major traffic accidents, and trap people in their homes.

Ice storms can break power lines, causing widespread blackouts.

Fire during winter storms presents a great danger because water supplies may freeze and the firefighting equipment may not be able to get to the fire.

One of the more serious dangers accompanying any winter storm is the threat of physical overexertion that can lead to heart attacks and strokes. While this occurs more often among older people, younger individuals also should take precautions.

## LONG-TERM DANGERS

If the storm lasts more than one or two days, there is a greatly increased possibility of utility failures and interruption of services. This can lead to extreme hardship and even death from extended exposure to cold temperatures.

## MITIGATION

Purchase a flood insurance policy to cover possible flood damage that may occur during the spring thaw.

## PREPAREDNESS

Be prepared for isolation at home, particularly if you live in a rural area. It is highly possible that a severe winter storm could isolate you for one or two weeks.

Insulate your home so you will be able to conserve heat better.

Use your radio, television, and newspapers to keep informed of current weather conditions in your area. You can better understand weather predictions by knowing the different types of winter storms. Knowledge of weather predictions will also help you to prepare better for the storm before it hits.

Have fuel and a safe type of emergency heating equipment available in case of power failures that would shut down standard furnaces. A camp stove with fuel or a supply of wood or coal for your fireplace could be used for emergency heat. Be prepared to keep at least one room of your house warm enough to live in for a week or two.

Be sure that all family members know how to use your emergency heating and lighting equipment safely to prevent fires or dangerous fumes. Proper ventilation is essential. Never use fuel in equipment that was not designed for that fuel. Burning charcoal will give off deadly amounts of carbon monoxide. Burning it indoors, even in a fireplace, is dangerous.

Stock an emergency supply of food and water. It is more practical to have some foods that do not require cooking or other preparation.

Should a power failure occur, have a battery-powered radio and extra batteries on hand so you can listen to weather forecasts, emergency information, and other advice broadcast by local authorities. Also, have flashlights, lanterns, candles, and matches ready for use.

Always have on hand simple tools and other equipment needed to fight a small fire. Winter storms may interrupt fire department services.

Keep your car winterized with antifreeze. Carry a winter car kit that includes food and water, a windshield scraper, a flashlight, a tow chain or rope, a shovel, tire chains, a blanket, a bag of sand or salt, a fluorescent distress flag, and an

emergency flare, in case you are trapped in a winter storm. Keep extra mittens, hats, and outerwear in the car.

## RESPONSE

Do not be fooled if a winter storm seems mild as it begins. Some storms may take several hours to move into an area and may last for several days.

Cold weather itself, without any physical exertion, puts an extra strain on your heart. If strenuous physical activity such as shoveling snow, pushing a car, or even walking fast or far through deep snow is added to your body's over worked system, you are risking serious or fatal results. In any cold weather, and especially during winter storms, be aware of this danger and avoid overexertion.

Avoid all unnecessary trips. If you are at home when a winter storm strikes, plan to stay there.

If you must be outdoors, wear several layers of loose-fitting, lightweight, protective clothing rather than a single layer of thick clothing. Mittens are warmer than gloves. Hoods should be worn to protect your head and face. Cover your mouth to protect your lungs from the extremely cold air.

If you are traveling and your car breaks down, or if you become stalled or lost, think through the problem, decide what is the safest and best thing to do, and do it slowly and carefully.

If you are stuck on a well-traveled road, display a trouble signal on your flashing hazard lights, raise the hood of your car, or hang a bright cloth from the antenna or car window.

Stay in your car and wait for help. Do not leave your car to search for assistance unless you are absolutely certain you can find help within one hundred yards of your car. It is very easy to become disoriented and lost during a severe storm.

While in your car awaiting assistance, take the following precautions.

- If you run your engine to keep warm, remember to keep snow away from the exhaust pipe. Keep a window open slightly to provide proper ventilation and protection from carbon monoxide poisoning.
- Do not let everyone in the car sleep at the same time.
- At night, turn on the inside dome light so work crews can spot you.

## RECOVERY

After the storm, check on the neighbors in your immediate area. Be sure they have proper heating and sufficient supplies to get them through the emergency.



Check roofs for damage from heavy snow.

Avoid overexertion while clearing snow by working slowly and taking frequent breaks, particularly if you become dizzy or tired.

Keep in mind that large amounts of snow can lead to localized flooding if warmer temperatures melt the snow in a short period of time.

## DROUGHT AND EXTREME HEAT

### SIGNS AND WARNINGS

Local community officials will alert you through your local newspaper, radio station, or television station when drought and extreme heat conditions exist in your area. Although extreme heat conditions are easily recognized, drought conditions develop so slowly that it is recommended that you keep track of local weather advisories so you can take proper action as drought conditions become more likely.

### IMMEDIATE DANGERS

There are three stages of danger from extreme heat.

- |             |  |
|-------------|--|
| Strain      | Occurs when hot weather and / or exertion threaten to raise your body core temperature above 99 degrees Fahrenheit.  |
| Impairment  | Occurs when your body temperature approaches 102 degrees Fahrenheit, creating an abnormal internal state that disrupts normal physical and mental functions. |
| Emergencies | When heat strain from overexposure lasts too long or becomes too severe, collapse from water depletion, heatstroke, or heart attack may occur.               |

### LONG-TERM DANGERS

A prolonged drought can have serious economic impact on a community. Agriculture production can be damaged or destroyed by loss of crops or livestock, resulting in food shortages. Increased demand for water and electricity can result in shortages of these resources. When combined with extreme heat, droughts can make life very difficult, especially if the situation lasts for a long time.

### MITIGATION

Practice personal water conservation measures to avoid depletion of water supplies both before and during periods of extended drought. An example of a water conservation measure is to place a brick, or other large, solid object, in the flush tank of your toilet. This reduces the amount of water used in flushing.

If you are a farmer, consider establishing alternative sources and supplies of water.

Conserve electricity. During periods of heat and drought, people use a lot of power for air conditioning. Excessive drain on the community's energy supply could lead to another emergency, such as a power shortage or outage. Insulating your home will reduce the demand for air conditioning; keeping the thermostat set to 78 degrees F will also reduce energy use.

## PREPAREDNESS

All family members should learn to recognize heat impairment symptoms and administer appropriate first aid.

HEAT DISORDER	SYMPTOMS	FIRST AID
Sunburn	Redness and pain. In severe cases swelling of skin, blisters, fever, headaches	Ointments for mild cases if blisters appear and do not break. If breaking occurs, apply sterile dressing. Serious, extensive cases should be seen by a physician
Heat cramps	Painful spasms usually in muscles of legs and abdomen. Heavy sweating	Firm pressure on cramping muscles, or gentle massage to relieve spasm. Give sips of water. If nausea occurs, discontinue use.
Heat exhaustion	Heavy sweating, weakness, skin cold, pale, and clammy. Pulse thready. Normal temperature possible. Fainting and vomiting.	Get victim out of sun. Lay down and loosen clothing. Apply cool, wet cloths. Fan or move victim to air conditioned room. Give sips of water. If nausea occurs, discontinue use. If vomiting continues, seek immediate medical attention.
Heat stroke (or sunstroke)	High body temperature 106 degrees F or higher Hot dry skin. Rapid and strong pulse. Possible unconsciousness	HEAT STROKE IS A SEVERE MEDICAL EMERGENCY. SUMMON EMERGENCY MEDICAL ASSISTANCE OR GET THE VICTIM TO A HOSPITAL IMMEDIATELY. DELAY CAN BE FATAL.  Move the victim to a cooler environment. Reduce body temperature with cold bath or sponging. Use extreme caution. Remove clothing, use fans and air conditioners. If temperature rises again Repeat process. Do not give fluids.

For more information, enroll in a First Aid course through your local Red Cross.

## RESPONSE

### Extreme Heat

During periods of extreme heat, limit your heat exposure by wearing loose-fitting, porous clothing, and a hat with a wide brim.

While in direct sunlight, keep as much of your skin covered as possible and use a sunscreen lotion with a rating of 15 or above. Sunburned skin cannot sweat.

Pace yourself while working. Begin at a very slow pace and continue until you achieve normal pulse and breathing rates at your working level. Do not exceed this pace.

Replace sweat by drinking water to keep the body fluid volume and salt level as close to normal as possible. Although beer and other alcoholic beverages appear to satisfy thirst, they cause further dehydration of your body.

Check with your physician to see if you should take additional salt during times of heat.

Rest regularly. This allows your natural cooling system to work. A few minutes of sweat-free rest every hour will help restore physical and mental energy. Soaking hands or feet in cool water also will help lower your body temperature.

### Drought

Curtail all non-essential water uses. Watering your lawn and washing your car are not essential to your well-being.

Re-use water whenever possible.

## RECOVERY

Continue to conserve water even after the drought appears to have ended.

If you own a farm and your crop is lost, contact the county Farmers' Home Administration Office for disaster assistance information.

## RELATED EMERGENCIES

Keep in mind that drought conditions, with or without extreme heat, can, greatly increase the risk of forest fires. As the forest dries up, debris on the forest floor, as well as the trees themselves, become prone to fire, even from the slightest spark. The loss of vegetation in the absence of sufficient water can result in flooding, even from average rainfall, following drought conditions.

## **WILDFIRE**

### **SIGNS AND WARNINGS**

Wildfires can occur at any time of the year, but usually are concentrated during hot, dry weather.

Wildfires are usually signaled by dense smoke that fills the air for miles around.

The National Weather Service, U.S. Forest Service, and State forestry agencies combine to give fire weather forecasts. Local radio and TV stations broadcast forecasts and warnings concerning local fire conditions.

Large forested areas may have watchtowers where spotters look for signs of fires and alert fire fighters immediately

### **IMMEDIATE DANGERS**

The immediate danger from wildfire is destruction of timber, property, wildlife, and injury or loss of human life. Persons who live in the affected area or who are using recreational facilities in the forested area where the fire breaks out are in danger of being trapped.

### **LONG-TERM DANGERS**

Wildfires can leave a large amount of scorched and barren land. This land may take many years or decades to return to its pre-fire condition. Major fires can destroy groundcover, which leads to erosion. If heavy rains follow a major fire, flash floods, landslides, and mudflows can occur. Once trees are gone there is nothing left to hold soil in place or to hold back rainwater or slopes.

### **MITIGATION**

Use only fire-resistant materials on the exterior of your home, including roof, siding, decking, and trim.

Use fire carefully and wisely so that you do not cause a fire. Teach family members safe practices.

Install a spark arrestor on your chimney.

Keep your chimney clean and avoid open burning during dry weather.

Store firewood well away from your home.

Clean roof surfaces and gutters regularly.

## PREPAREDNESS

Learn how to recognize dangerous fire conditions.

Provide wide spacing between trees. For trees within 100 feet of your house, remove tree limbs within 15 - 20 feet of the ground or over roofs, and limbs that are above or near a chimney.

Use fire-resistive plants. Check with local fire officials about the best species for your area.

Plan several evaluation routes in case fires block your escape.

Clear an open space around your house to serve as a fire break - at least 30 feet wide for all structures and 75 feet wide for homes built in pine forests.

Have fire tools handy: a ladder, garden hose, shovel, rake, and bucket.

## RESPONSE

If water sprinklers and adequate water are available, leave sprinklers on roofs and anything else that might be damaged by fire. Be sure that efforts by you and your neighbors to protect your property do not leave firefighters without the huge amounts of water that will be needed to fight the blaze. Place valuables that will not be damaged by water in a pool or pond, or take them with you.

If officials are evacuating your area, do not hesitate to leave. Fires can spread rapidly and unpredictably.

If you are on an outing in a forest when a fire breaks out, note the weather conditions and wind direction. Find out the direction of the fire and plan your escape routes in other directions. Evacuate quickly - fires can spread at rapid speeds.

If you are caught in a wildfire, knowledge of survival techniques could save your life.

- Look for a nearby body of water and crouch in it, covering your head and upper body with a wet shirt or other article of clothing.
- Look for a rock outcropping or cleared area to obtain shelter from the fire.
- If possible, breathe through a wet handkerchief or wet piece of clothing to avoid scorching your lungs or inhaling smoke.
- Oxygen may be in short supply, so try to remain calm to reduce the rate at which you use oxygen. If possible, breathe the less smoky air close to the ground.

- Do not try to outrun a fire that is burning uphill. Instead, move at right angles

## **RECOVERY**

Care must be taken in reentering burned forest areas. There still may be hotspots that could flare up without warning.

Replant burned-out forests quickly and efficiently in order to reduce the soil erosion caused by the loss of trees in an area. Ask your State forestry commission for guidelines.

Consult your insurance agent and have damages assessed as soon as possible.

## **RELATED EMERGENCIES**

Keep in mind that landslides, mudflows, and floods can occur following a wildfire. Once trees and ground cover have been burned away, there is not much left to hold soil in place on steep slopes and hillsides.

## **EARTHQUAKE**

### **SIGNS AND WARNINGS**

Earthquakes usually occur without warning. If an earthquake is occurring in your area, you will feel a trembling in the ground or floor. You may notice curtains or trees vibrating and swaying.

Earthquake monitoring is conducted by the U.S. Geological Survey, the National Oceanic Atmospheric Administration, and universities throughout the United States. However, the exact time and place an earthquake will occur still cannot be predicted precisely.

Earthquakes tend to reoccur along fault lines (fractures in the earth's surface). Though quakes usually strike without warning, scientists have produced risk maps that show areas where an earthquake is likely to occur. Other clues to the probability of a quake come from studying faults, measuring the tilt of the earth's crust, watching changes in the water levels of wells, and even observing the behavior of animals.

### **IMMEDIATE DANGERS**

The actual movement of the ground is seldom the direct cause of death or injury. Earthquake-related casualties are commonly caused by (1) partial or total building collapse, including toppling chimneys or walls, falling ceiling plaster, light fixtures, and pictures; (2) flying glass from broken windows and skylights (this danger may be greater from windows in high-rise structures); (3) overturned bookcases, fixtures, and other large furniture and appliances; (4) fires from broken chimneys and broken gas lines; (5) fallen power lines; and (6) an inappropriate or drastic human reaction caused by fear.

Fires caused by earthquakes are particularly dangerous. Water mains may be broken and fire fighting equipment may be unable to reach the fire. Broken gas lines often are a major cause of earthquake-related fires.

### **LONG-TERM DANGERS**

Earthquakes can cause damage to buildings, utility lines, bridges, or dams. Water supplies can become contaminated by seepage around broken water mains. Damage to roadways and to other means of transportation may create food and other resource shortages if transportation is interrupted.

### **MITIGATION**

Check your home for potential earthquake and fire risks. Bolt down or reinforce water heaters and other gas appliances, since fire damage can result from broken gas lines and appliance connections. Use flexible connections wherever possible. Place large and heavy objects on lower shelves, and securely fasten shelves to walls. Brace-anchor all tall or top-heavy objects.



Affix tabletop equipment (such as computers or typewriters) with industrial strength Velcro. Overhead lighting fixtures should be anchored solidly in place. A little extra wire is usually all that is necessary.

Deep plaster cracks in ceilings and foundations should be investigated and repaired by experts, especially if there are signs of structural defects.

Be sure the house is firmly anchored to its foundation.

Purchase earthquake insurance.

Support local safe land use and building codes that regulate land use along fault lines. Insist on code inspection and enforcement in areas where damaging earthquakes can be expected. Modern engineering can produce structures that resist earthquake damage much better than older masonry buildings, and existing buildings can be "retrofitted" to better withstand tremors. If you live in a high-risk area where no such regulations or codes exist, you should support their enactment.

## **PREPAREDNESS**

Provide your family with the knowledge of how to protect themselves during an earthquake. Conduct calm family discussions about earthquakes and other possible disasters. Do not tell frightening stories about disasters. Be prepared to survive for 72 hours without any assistance, even from local resources.

Help organize and support earthquake preparedness programs in your community. For example, your local emergency management agency, schools, volunteer agencies active in disasters, or civic organizations could hold earthquake drills and public education programs to prepare citizens for when earthquakes occur.

Teach responsible members of your family how to turn off gas, electricity, and water at main switches and valves. Check with your local utilities offices for instructions.

Learn how to extinguish small fires and to provide emergency first aid.

Conduct family earthquake drills. Know where the safest places are at home, work, or school.

Ensure that batteries are on hand for your radio and for flashlights in the event of power failure.

## **RESPONSE**

Above all, remain calm, try to reassure others, and think through the consequences of any action you take. If you are indoors, stay indoors; if outdoors,

stay outdoors.

If you are indoors, take cover under a sturdy piece of furniture (such as a heavy desk, table, or bed) to protect yourself from falling objects such as falling plaster, bricks, light fixtures, high bookcases, china cabinets, shelves, and other furniture that might slide or topple. Stay away from objects that can shatter (such as windows, mirrors, or skylights) and from chimneys. DO NOT run outside - you could be injured by falling objects or live wires. Encourage others to follow your example.

If you are in a high-rise building, do not dash for exits. Stairways may be broken or jammed with people. Power for elevators may fail.

If you are in a crowded store or mall, do not rush for a doorway since many other people may have the same idea. If you must leave the building, choose your exit as carefully as possible.

If you are outside, get away from buildings, walls, utility poles, downed wires, and all other objects that could fall. If possible, move to an open area away from hazards and stay there until the shaking stops.

If you are in a car, stop as quickly as safety permits, but stay in the vehicle until the shaking stops. Avoid bridges, underpasses, and tall buildings.

Check for injuries and attend to them; seek medical help if necessary.

Check for fires or fire hazards.

## RECOVERY

If you are unsure of a building's safety, do not enter until it has been inspected by a qualified person.

Check utilities. Earth movements may have broken gas, electrical, and water lines. If you smell gas, open windows and shut off the main gas valve. Shut off electrical power if there is damage to your house wiring. Leave the building and report damage to the appropriate utility companies; follow their instructions. Do not use matches, lighters, or open-flame appliances until you are sure there are no gas leaks. Do not operate electrical switches on appliances if gas leaks are suspected.

Do not eat or drink from open containers near shattered glass.

Immediately clean up spilled medicines and potentially harmful materials.

Check to be sure that sewage lines are intact before permitting toilets to be flushed.

Do not use your telephone except for genuine emergency calls. Turn on your

battery-operated radio for damage reports and information.

Check closets and all storage shelf areas. Open closet and cupboard doors carefully, watching for objects falling from the shelves.

Check your chimney over its entire length for cracks and damage. First check from a distance, and then move closer if it appears to be safe. Check particularly in the attic and at the roof line. Unnoticed damage could lead to a fire. Always approach chimneys with extreme caution.

Be prepared for additional earthquake shocks (called aftershocks). While the aftershocks are usually smaller than the main shock, some may be large enough to cause additional damage.

Have damage to your home assessed by your property insurance claims adjuster.

Do not go sightseeing; stay away from beach and water front areas where seismic sea waves (tsunamis) may strike. Keep the streets clear for passage of emergency vehicles. Stay out of severely damaged buildings. Aftershocks can shake them down.

Execute repairs that will increase the structure's ability to withstand future quakes.

## **RELATED EMERGENCIES**

Keep in mind that natural disasters, such as earthquakes, have the potential to trigger other emergency conditions such as tsunamis, fires, major landslides, dam failures, power plant ruptures, and hazardous materials spills. Be certain you are prepared for all of these disasters if you live in an earthquake-prone area.

## **TSUNAMI**

### **SIGNS AND WARNINGS**

If you live near a coastal area and have experienced or heard of a recent earthquake or volcano, listen to your radio for a tsunami warning. The Pacific Tsunami Warning System in Honolulu issues tsunami warnings to affected coastal areas.

Tsunamis can be detected before they strike land. If you hear of a tsunami warning, do not go down to the beach to look for the tsunami. If you can see it, you will be too close to escape it.

Approaching tsunamis usually are preceded by a pronounced rise or fall of coastal water. This action is nature's tsunami warning and should be heeded. Many people have been trapped while exploring the newly uncovered sea bottom in the aftermath of a rapid retreat of ocean water beyond the normal low-tide line.

The Pacific Warning System in Honolulu monitors disturbances that could trigger a tsunami. Local warning systems, developed for Alaska and Hawaii, augment the Pacific system. When a tsunami is spotted, it is tracked and a tsunami warning is issued to the threatened area. This warning should be heeded.

Your community may be warned by radio or television announcements. Local police, fire, or emergency officials may go door-to-door in threatened areas. Outdoor sirens may sound to warn of the dangers.

### **IMMEDIATE DANGERS**

Immediate dangers from tsunamis are drowning, flooding, and widespread property damage.

### **LONG-TERM DANGERS**

Associated risks include broken sewage lines, polluted water supplies, damaged gas lines, and downed power lines.

### **MITIGATION**

The most effective mitigation measure to avoid property damage is not to build or live in buildings within several hundred feet of the Pacific coastline. Even the strongest buildings can be damaged or undermined by a powerful tsunami.

If you must live in a coastal building, purchase flood insurance to assure that you will be financially protected in the event of a flood-related loss.

## PREPAREDNESS

Plan several escape routes to high ground. Your primary escape route might be damaged or destroyed if a local earthquake strikes. Be prepared to evacuate low-lying coastal areas immediately.

Learn the warning signs and signals and heed them.

Stay off the beach during unusual tidal action.

## RESPONSE

Upon hearing an official tsunami warning or detecting signs of a possible tsunami, move inland to higher ground as quickly as possible. Tsunamis can travel at such tremendous speeds that any warning must be acted upon immediately.

Since a tsunami is not a single wave but a series of waves, stay out of dangerous areas until an "all clear" is issued by an authorized official.

Check for injuries and seek medical help if necessary.

## RECOVERY

If your home, apartment, or business has been damaged, immediately call your insurance agent, who will advise you what to do next.

Do not use fresh food that has come in contact with floodwaters. Have all drinking water tested by your local health department before use wells should be pumped out and the water tested before drinking.

Before entering a building air it out for several minutes to remove foul odors or escaped gas.

Upon entering the building, do not use a match or a lantern as a source of light because of the danger of gas build-up; use a battery-powered flashlight instead. Check for electrical shorts and live wires. Make certain power is turned off, and do not use any appliances or lights until an electrician has checked your electrical system.

Open all doors and windows to help the building dry. Shovel out mud while it is still moist to give walls and floors an opportunity to dry.

## **VOLCANIC ERUPTION**

### **SIGNS AND WARNINGS**

A volcano may show signs of erupting weeks or months in advance. Earthquakes, earth tremors, and steam vents around a volcano can signal an eruption.

Volcanoes can erupt with a force that makes the earth tremble and fills the air with a deafening roar.

The U.S. Geological Survey assesses all information related to the development of impending geological disasters. They inform the public and appropriate local, State, and Federal authorities. Warnings include information about the approximate time, place, and extent of the effects, as well as the uncertainties involved in making the prediction.

Communities located near active volcanoes should have warning sirens to be sounded if a major erupt on occurs.

### **IMMEDIATE DANGERS**

The degree of hazard to human life and property resulting from a volcano depends upon the type and distance from the eruption. Hazards include lava flows, rock falls, earthquakes, mudflows, and flash floods.

### **LONG-TERM DANGERS**

Secondary eruptions and lava flows can occur days, weeks, or months after a volcanic eruption.

Hazards within the immediate vicinity of the volcano come from heavy ash fall, which can darken the sky as if it were nightfall. The increased demand for electric lighting could result in power failures. The ash may be carried by winds for thousands of miles and affect distant areas long after the eruption.

The ash is actually pulverized rock. A one-inch layer weighs ten tons per square foot. Ash can clog waterways, reservoirs, and machinery, and its weight can cause roofs to collapse.

### **PREPAREDNESS**

Learn methods of protecting your family and home from ash fall from your local emergency office.

Have emergency lighting and heating supplies available in case of a power failure.

## RESPONSE

Heed official warnings of imminent volcanic eruption. If told to evacuate, do so immediately.

If caught in a small rock fall (not a landslide); roll into a ball and protect your head!

Immediately following an eruption, flash floods resulting from glacier out bursts can overflow dams and reservoirs. Avoid stream beds and valleys in the vicinity of a volcano. If caught in a low area, run uphill to avoid a flash flood or mudflow.

During ash fall, close all windows, doors, and dampers in your home. Put all machinery inside a garage or barn. Bring animals and livestock into closed shelters. If ash is falling, stay indoors until the ash has settled.

If caught outside during ash fall, keep your mouth and nose covered to avoid inhalation of ash. Cover your eyes and keep your skin covered to avoid irritation or burns.

Do not attempt to drive in, heavy ash fall. Driving will stir up more ash and ultimately clog and stall your vehicle.

## RECOVERY

Clear roots of ash fall as soon as possible to avoid collapse from too much weight.

## RELATED EMERGENCIES

Volcanic eruptions can generate mild to moderate earthquakes, mudflows, flash floods, and huge ash clouds, which can create intense lightning storms.

## **DAM FAILURE**

### **SIGNS AND WARNINGS**

Your area may have an outdoor warning signal. Warnings may be issued by sirens, horns, radio, television, or door-to-door canvassing by local emergency personnel.

Federal agencies conduct stream-flow monitoring to provide advanced warning of a flash flood.

### **IMMEDIATE DANGERS**

The immediate dangers the powerful torrent of rushing water that causes injuries, drowning, and property damage from collapsed buildings and bridges.

The potential for catastrophic loss of life and property damage is great because of the speed and devastating power of such large amounts of rushing water.

### **LONG-TERM DANGERS**

Associated risks include the potential for the spread of disease, animal deaths, and a contaminated water supply. Utility equipment can be damaged, resulting in power outages and possible fires and explosions. Buildings may be dangerously weakened.

### **MITIGATION**

Before you build or buy a home below a dam, learn as much as you can about its safety record and the safeguards followed by the owners.

When you build, follow local building codes and take extra measures to reinforce and flood proof your home or building.

Flood insurance is available through the National Flood Insurance Program. You can buy this insurance coverage through your property insurance agent before an emergency occurs.

Attend public meetings to learn your area's dam failure preparedness plans.

Support strong local and State dam safety programs.

### **PREPAREDNESS**

Learn your community's warning systems.

If you are in a risk area, plan several alternate evacuation routes to higher ground.



## RESPONSE

If an emergency flash flood warning is issued, do not hesitate. Go to higher ground immediately and stay there.

If you hear the roar of a rushing torrent of water, get to the highest ground possible. If you can hear the roar, you may have only seconds to reach safety.

Stay in your safe spot until the water has subsided or an all clear announcement is made over local media or by a local emergency official.

## RECOVERY

If your home, property, or business has been damaged, Immediately call your insurance agent, who will advise you what to do next.

Do not use food that has come in contact with floodwaters. Have all drinking water tested by local health authorities before using. Wells should be pumped out and the water tested before drinking.

Avoid loose or dangling electrical wires, and report them to the utility company.

Report broken sewer lines or water mains to the water department.

Before entering a building, check for structural damage; make sure it is not in danger of collapsing.

Open the building and let it air out for several minutes before entering to remove foul odors or escaped gas.

Upon entering the building, do not use a match or lantern as a source of light because of the possibility of gas buildup; a battery-powered flashlight is recommended. Check for electrical shorts and livewires. Make certain the power is turned off; do not use appliances or lights until an electrician has checked the electrical system.

Open all doors and windows to help the building dry. Shovel out mud while it is still moist to give walls and floors an opportunity to dry.

## 4. Technological Hazards: Applying the Four Phases

### HAZARDOUS MATERIALS

#### SIGNS AND WARNINGS

When an emergency occurs involving hazardous substances, people in the area will be alerted by police, fire officers, or highway patrol personnel. Warnings and instructions also will be issued through radio and television.

#### IMMEDIATE DANGERS

Immediate dangers from hazardous materials include fires, explosion, and the possible contamination of a community's air, land, and water.

The release of some toxic gases may cause immediate death or disablement if inhaled.

Contaminated water resources may be unsafe and unusable, depending on the amount of contaminant.

Some chemicals cause painful and damaging burns to skin if you come in direct contact with them.

Contamination of air, ground, or water may result in harm to fish, wildlife, livestock, and crops.

Many dangerous substances have little or no color or odor; other substances that do smell often will quickly disable one's sense of smell. Therefore, signals that alert the human senses are very unreliable and may be unsafe. Assume the worst when acting for your safety or on behalf of others. KEEP A SAFE DISTANCE.

A number of chemicals are skin-absorbed nerve toxins, which are often odorless and colorless. Frequently a long delay exists between exposure and the onset of symptoms. These symptoms can be agonizing and often are enhanced because the victim stayed in the danger zone while thinking there was no risk, due to the lack of smell or color. Again, assume the worst.

#### LONG-TERM DANGERS

The release of hazardous materials into the environment may cause debilitation, disease, or birth defects over a long period of time.

Loss of livestock and crops may lead to economic hardships within the community and to food shortages in communities supplied by the affected area.

Exactly how the loss of wildlife would affect a particular area is unknown. Certainly the economy of a community that is dependent on its wildlife would suffer.

## MITIGATION

Use data accessible through Title 111 to identify companies in your community that manufacture or use dangerous chemicals and substances. Learn what the chemicals are, their hazardous properties, and their dangerous effects. Find out if antidotes are available. Ask the manufacturer for a copy of the product's safety sheet.

Try to avoid building or buying a house near potentially dangerous chemical sites.

## PREPAREDNESS

Know what hazardous substances may be in your community, and by what routes they are transported.

Keep clearly labeled antidotes on hand for any hazardous substances you store at home. Family members should know when and how to use them.

Post the number of the nearest poison control center by the telephone.

Have several evacuation routes planned in case an emergency develops in your community.

Keep foam-type fire extinguishers in your home and car. Consult your local fire department for recommendations.

Learn to recognize symbols and identifiers on placards that mark carriers containing hazardous substances.

## RESPONSE

If you are at or near the scene of a chemical accident...

- Do not walk toward the spill or touch any spilled material.
- Do not inhale gases, fumes, and smoke.
- Do not assume that gases and vapors are harmless merely because there is no odor.
- Move away from the accident. Try to stay upstream, uphill, and upwind. You should go at least 10 city blocks (one-half mile) from the danger area; for many incidents. You may need to go further if so advised by emergency response personnel.
- If the wind is coming from the accident area do not move directly toward or away from the wind. Move so that you feel the wind on the side of your face to avoid the direct path of the fumes.

- If the wind is blowing toward the accident, walk away from the accident and into the wind.
- After you are safe, immediately contact emergency services: police, highway patrol, fire department, or emergency medical services. If your community has one telephone number for all emergencies, such as 911, report the nature and location of the accident, and the dispatcher will contact the appropriate service.
- DO NOT INTERVENE in any way. Lack of training in proper procedures could endanger you and others. Wait for authorities and trained personnel.

If you are at home, work, or school, local officials may ask you to evacuate or to remain indoors and seek in-place protection.

If you are asked to evacuate...

- Do so immediately; quick and efficient evacuation can greatly reduce or eliminate any danger. Information on where to go, how to get there, and what to take is discussed in Unit Six.

If you are instructed by authorities to seek in-place protection...

- Close windows and doors, and seal cracks with wet towels, blankets, or tape.
- Turn off all ventilation, including furnaces, air conditioners, vents, and fans.
- Remain in protected areas such as hallways and away from windows until danger has passed. Keep a radio with you to remain updated.

## RECOVERY

Follow local instructions concerning the safety of locally available food and water.

Clean up and dispose of residue carefully. Follow instructions from emergency officials concerning clean-up methods.

State and Federal agencies are prepared to assist in the clean-up of chemical spills. Such agencies utilize containment and scrubbing equipment, special, neutralizing materials, and other apparatus specifically designed for such emergencies.

If you want to learn more about hazardous materials, take FEMA's home study course Hazardous Materials: A Citizen's Orientation(HS-5). The course addresses hazardous materials and human health, regulations governing hazardous materials, identification of hazardous materials, preparation for hazardous materials incidents, and hazardous materials in the home.

## RADIOLOGICAL ACCIDENT

### SIGNS AND WARNINGS

An individual cannot detect radiation by sight, smell, or any other sense. However, you should learn the emergency warning system in your community if you live near a nuclear power plant, a major shipping route, or a facility that stores nuclear materials, wastes, or spent fuels. This radiation symbol marks areas of buildings and containers where radioactive materials are used and stored.

If an accident occurs involving radioactive materials, many emergency services are likely to be involved in the response. If the radiation levels are dangerously high, the area immediately around the accident site may be evacuated. The size of the evacuated area will depend on the type and amount of radiation and on weather factors. Special warning systems such as sirens, tone-alert radios, and/or route alerting have been established around nuclear Markings on this map denote the area power plants to alert the public during time of down wind of a nuclear power plant that emergency might be evacuated in the event of an incident. The size of the evacuated area is determined by the weather and by the type and amount of radiation released.

### IMMEDIATE DANGERS

Radioactive materials emit different types of radiation, each of which presents its own danger to the human body. Some types of radiation can penetrate the skin and travel through the body. If the level of radiation is high, these types are dangerous just from being close to them. This danger is called an external radiation hazard. Other types of radiation are more dangerous when the radioactive materials are taken inside the body by inhaling contaminated air, getting the radioactive material in open wounds, or eating or drinking radioactive substances. This danger is called an internal radiation hazard.

All radiological accidents will not necessarily result in radiation exposures that can cause severe health effects and possible death. Due to packaging requirements and other regulations, an accident involving the transport of radioactive material may not even result in a release of the material into the environment. The potential health effects resulting from a radiological accident will depend on the type and quantity of radioactive material released and the amount of exposure received. An accident involving the shipment of small quantities of radiopharmaceuticals to hospitals would be far less severe than an accident involving the release of a significant quantity of radioactive materials from a commercial nuclear power facility.

The immediate danger from radiological accidents is from exposure to radiation, either internally or externally. The level of radiation that is harmful depends on the total amount of exposure. Radiation effects are cumulative. The greater your total exposure, the higher the risk of serious damage to your body.

The danger from external radiation varies depending on the type of radiation, the

length of the exposure, the distance you are from the source of the radiation, and the amount of shielding between you and the source. Your body weight and general state of health also are factors to be considered.

Radiation exposure causes damage to the cells of the body. Any exposure to radiation is likely to cause some cell damage. Your body can recover from a limited exposure to a small amount of radiation. The more you are exposed to radiation, the greater the cell damage and the more likely you are to become ill.

Radiation sickness can result from a single exposure to a large amount of radiation or from repeated exposure to small amounts. The more exposure and the more cell damage, the greater the effect on your body. If many cells are damaged, you are likely to experience more severe symptoms such as nausea, vomiting, and diarrhea. Radiation exposure can also impair the production of white blood cells and weaken the body's ability to fight infection. Therefore, a high degree of total radiation exposure makes your body susceptible to infection. The combined effect of high cell damage and lowered resistance causes severe radiation sickness and possible death. In cases of very high exposure, death is probable.

If radioactive substances are taken internally, the damaging rays continue to be emitted while natural radioactive decay occurs. The natural process of the body may get rid of some of the radioactive substances, but others may be retained.

Radiation sickness is not contagious. You cannot catch radiation sickness from someone who has been exposed to radiation. The illness is a result of cell damage and the weakening of the body's defenses. No drugs can cure radiation sickness. Medical care and antibiotics can reduce the danger from infection while the body repairs itself.

The chances of recovery depend on the amount of damage and the general state of health at the time of exposure. Children, pregnant women, and persons in poor health are likely to experience greater damage from smaller total amounts of radiation than adults in good health.

The only way to avoid radiation sickness is to avoid exposure to external hazards, avoid breathing radioactive dust particles in the air, and avoid consuming contaminated water or food. If you cannot avoid the exposure, at least limit the exposure as much as possible. Seek medical help if you know that you have been exposed or that you have consumed contaminated food or water.

## **LONG-TERM DANGERS**

Although the effects of radiation many months or years after exposure are not clearly known, but they are thought to include leukemia, cancer, cataracts, sterility, birth defects, and genetic disorders. While radiation itself may not be the cause of these effects, scientists believe that a link exists between exposure to dangerous levels of radiation and the chances of suffering some of these effects later.

## MITIGATION

Know the locations of nuclear power plants, radioactive storage sites, radioactive waste dumps, and facilities that use radioactive materials in or near your community.

If you live near a nuclear power plant, attend public information meetings to learn about radioactivity, safety precautions, and mitigation measures being taken by the utility company, the local community, and the State.

## PREPAREDNESS

Public information materials are available from all nuclear power plants to tell you what actions to take in the event of an emergency at the plant. If you live within 10 miles of such a facility and have not received these materials in the mail, call the operating company or the local emergency management office and ask for a copy. You should read and retain these materials and refer to them in time of emergency.

Know which emergency broadcast radio or television stations (and station frequency or channel number) will be used to announce warnings and emergency instructions.

Keep an emergency supply of food, water, and any special medicines required by you and your family members. (Unit 6 will provide specific information on supplies you would be likely to need.)

Have several evacuation routes planned. Your routes should be consistent with those planned by emergency management officials. Know what to take, how to locate family members at anytime of the day or night, and how to close your house so that you can leave promptly.

## RESPONSE

If a radiological accident occurs in your community, remain calm. Listen to local radio or television for announcements. If you or your home is in any danger, local emergency officials will advise you by radio or television of the actions you should take.

If you are told to evacuate, do so immediately. Follow the officially recommended route, even if it is crowded. You will be sent in a direction that will not put you in danger of the radioactive plume carried by the wind.

If you are told to take shelter in your home or office, stay there. Close doors and windows. Turn off fans. Do not run air conditioners unless emergency officials tell you it is safe to do so. Stay in your basement or in a central part of your house. Listen to your local radio or television station for emergency information. Do not go outside until an all clear announcement is made.

There are three ways to minimize radiation exposure to your body: shielding, distance, and time.

- Shielding      Heavy dense material between you and the source of the radiation can serve as protection.
- Distance      The more distance between you and the source of radiation,  
radiation,      the less radiation you will receive.
- Time            Limiting the time spent near the source of radiation reduces the amount of radiation you will receive.

When the immediate danger has passed, avoid using foods from your garden or milk from your cows or goats until these can be inspected by a local emergency



## **STRUCTURAL FIRE AND EXPLOSION**

### **SIGNS AND WARNINGS**

Fire alarms are installed in public buildings. Other warning devices, such as smoke detectors, can alert families to fire in their homes. Intense heat, flames, and smoke are recognizable signs of fire in a structure. Explosions usually are accompanied by a loud bang, blast waves, and flying debris.

### **IMMEDIATE DANGERS**

Heat and smoke present the most immediate danger from structural fires. The force of an explosion may cause injury or unconsciousness. In crowded public buildings, panicked behavior may present the greatest danger.

### **LONG-TERM DANGERS**

The spread of fire to other buildings or to fuel supplies could cause their destruction and long-term economic effects.

### **MITIGATION**

Teach family members the proper way to handle fire. Fire safety information is available from local officials, the State Fire Marshal's Office, the U.S. Fire Administration, and the American Red Cross.

Follow fire and life safety building codes when building a home. Avoid the use of materials that have proven particularly vulnerable to fire or could foster its spread to other houses, such as many types of wooden shingles and shakes. In older homes, have wiring and fire places inspected by a fire safety inspector in a home of any age, chimneys must be cleaned regularly to avoid the possibility of a chimney fire that could spread to the roof and other parts of the house. Be sure that wood stoves are properly installed. Incorrect installation, often by home owner's is a common cause of fires in some areas.

Do not store combustible materials in closed areas or near a heat source.

Do not overload electrical circuits.

Replace frayed electrical cords.

Buy fire insurance for your home and/or business.

### **PREPAREDNESS**

Plan alternate escape routes from all levels of your house. Review the plan with all family members.

Hold periodic fire drills.

Install metal or rope ladders as fire escapes from the upper floors of your house.

Install smoke detectors and test them every month. If you own a business, install fire alarms and sprinkler systems. Replace the batteries at least once each year, or as indicated in the instructions. Smoke detectors, alarms, and automatic sprinklers are preventive measures designed to discover and suppress fires before they spread.

Equip your home with residential fire sprinkler systems to assure a safer environment for your family and protection of your investment and irreplaceable family possessions.

Post the number for the fire department and emergency medical service by the telephone. Teach all family members how to report a fire emergency.

Teach family members what to do in various fire conditions, such as heavy smoke or blocked exits.

Keep fire extinguishers in your home and car. Learn how to use them, and teach family members. Ensure that these are inspected regularly. Read the instructions on the extinguisher for inspection details.

Learn how to treat burns; contact your local Red Cross for available first aid courses.

## RESPONSE

If you see a fire, immediately report it to the local fire department. Give clear and exact information concerning the fire's location.

If a fire alarm sounds in a public building, leave immediately. Remain calm. Do not run. Use fire exits or stairs. Do not use elevators.

If possible, contain the fire. Use the correct firefighting method. If there is an electrical fire, do not use water unless the electricity is turned off. If a flammable liquid is burning, smother it; do not splatter it.

Stay low in a burning building. Heat and smoke will rise. Hot air can scorch your lungs and smoke may contain toxic fumes. Take short breaths and, if possible, cover your face with a damp cloth and breathe through your nose.

Be sure of your escape route. Do not let the fire get between you and away out.

Check doors before opening them. If a door is hot, do not open it. Open a door carefully if it is cool, keeping your head to one side to avoid any blast of hot air.

If your clothing catches fire, drop and roll.

Once you and your family safely escape a fire, do not go back inside a building for any reason.

## RECOVERY

Have the damage to your home assessed by your insurance company. File a claim as soon as possible.

You may need to find temporary housing, food, clothing, and other assistance. Your insurance company may help to pay for the expense, or you can contact your local chapter of the American Red Cross or the Salvation Army.

## 5. Preparing Your Family Disaster Plan

There are four steps to creating a family disaster plan.

1. Find out what could happen to you. You need to confirm the analysis of the hazards most likely to affect your community that you completed earlier in this course and learn more facts about your community's preparedness plans.
2. Create a disaster plan. You need to meet with other household members to determine how you can work together as a team to survive a disaster.
3. Complete preparedness activities. FEMA has identified a number of activities you can perform that will help your family prepare for a disaster.
4. Practice and maintain your plan. It is important to be sure your family remembers what steps should be taken if a disaster should occur, and that certain preparedness measures should be carried out regularly.

### 1. FIND OUT WHAT COULD HAPPEN TO YOU

### 2. CREATE A DISASTER PLAN

### 3. COMPLETE THESE PREPAREDNESS ACTIVITIES

Learn how to give first aid.

Learn how to perform cardiopulmonary resuscitation (CPR).

Post emergency phone numbers.

Ensure that all household members can summon help in an emergency.

Learn how to shut off utilities.

Know how to purify water.

Boiling

Purification tablets

Bleach purification (2-4 drops per quart)

Assess your insurance coverage.

Determine the best escape routes from your home, in case regular exits are blocked.

Find safe places in your home for each hazard.

Conduct a home hazard hunt.

Check for electrical hazards.

Check for chemical hazards.

Check for other fire hazards.

Check fire safety equipment.

**PRACTICE AND MAINTAIN YOUR PLAN**

## **SAMPLE MEDICAL RELEASE FOR A CHILD**

This is a sample form of a Medical Release form Minor Child, which may permit treatment in an emergency. While there are other methods for hospitals and other medical facilities to obtain permission to treat a minor child in the absence of parental consent, it's a good idea to have one of these permission slips on file in your child 's school and at your doctor's office, as well as the nearest hospital, just to be sure there is no delay in case of an emergency. Many schools provide their own medical release forms. This information should be updated annually. You should consult with your physician to determine what specific information is required in your State.

I, \_\_\_\_\_, Parent or Legal Guardian of a minor child, hereby authorize any Medical or Surgical treatment that maybe necessary in an emergency, and in my absence, for the well being of the above mentioned minor. I agree to hold the physician or hospital treating the above mentioned minor harmless.

\_\_\_\_\_ has the following Allergies: \_\_\_\_\_

and has the following Medical Conditions: \_\_\_\_\_

### **Hospital Insurance**

Name of Company \_\_\_\_\_

Policy Number \_\_\_\_\_ Group Number \_\_\_\_\_

Date \_\_\_\_\_ Signature of Parent or Legal Guardian \_\_\_\_\_

-----

### **Meeting Places and Contacts**

Meeting Place In Neighborhood \_\_\_\_\_

Outside the Neighborhood \_\_\_\_\_

### **Family Contact (long distance)**

If we are separated in an emergency, we will all contact the following person and give our location and phone number:

Name \_\_\_\_\_

Phone Number \_\_\_\_\_

Address \_\_\_\_\_

## EVACUATION CHECKLIST

Evacuate **IMMEDIATELY** if told to do so.

Listen to your battery-powered radio and follow the instructions of local emergency officials. Remember, your home and possessions can be replaced.

Wear protective clothing and sturdy shoes. Take your Disaster Supply Kit. Lock your home (windows and doors). Use travel route specified by local authorities don't use shortcuts, as certain areas maybe impassable or dangerous.

If you're sure you **have** time...

Shut off water, gas, and electricity before leaving, if instructed to do so.

Tell someone when you left, your destination, medical condition of family members, and whether all family members are accounted for.

Take pets to predetermined animal shelter areas.

Turn off lights and electrical appliances.

Turn down heat or air conditioner.

Put away all perishable foods.

## EMERGENCY TELEPHONE NUMBERS

Fire Department \_\_\_\_\_

Paramedics \_\_\_\_\_

Ambulance \_\_\_\_\_

Poison Control Center \_\_\_\_\_

Doctor \_\_\_\_\_

Hospital Emergency Center \_\_\_\_\_

Police Department \_\_\_\_\_

County Sheriff \_\_\_\_\_

Search and Rescue \_\_\_\_\_

Coast Guard / Harbor Patrol \_\_\_\_\_

Other \_\_\_\_\_

Other \_\_\_\_\_

Father Work \_\_\_\_\_

Mother Work \_\_\_\_\_

Local Friend/Relative (name/phone) \_\_\_\_\_

Out-of-State Contact (name/phone) \_\_\_\_\_

## UTILITY INFORMATION

### Location of Utility Shut-Offs

Main gas valve outside of home \_\_\_\_\_

Location of wrench or gas shut-off tool \_\_\_\_\_

Water valve inside of home \_\_\_\_\_

Main water shut-off valve near sidewalk or street \_\_\_\_\_

Shut-off tool for above \_\_\_\_\_

Electrical panel (fuse or breaker box) in home \_\_\_\_\_

House electrical meter (main disconnect switch) outside \_\_\_\_\_

Other \_\_\_\_\_

## DISASTER SUPPLIES

### WATER

Water should be stored in plastic containers such as soft drink containers. Avoid using containers that will break, such as milk cartons or glass bottles. A normally active person needs to drink at least two quarts of water each day. Hot environments and intense physical activity can double that amount. Children, nursing mothers, and ill people will need more.

Store one gallon of water per person per day (two quarts for drinking and two quarts for food preparation/ sanitation).

## FOOD

Store at least a three-day supply of non-perishable food. Select foods that require no refrigeration, cooking, or preparation, and little or no water. If you must heat food, include a can of Sterno. Select food items that are compact and lightweight. Take into account your family's food preferences.

Ready-to-eat canned meats, fruits, and vegetables

Canned juices, milk, soup (if powdered, store extra water)

Staples and sugar, salt, pepper

High energy foods and peanut butter, jelly, crackers, granola bars, trail mix

Comfort/stress foods and cookies, hard candy, sweetened cereals, lollipops, instant coffee, teabags

Vitamins

Foods for infants, elderly persons, or people on special diets

## FIRST AID KIT

Sterile adhesive bandages in assorted sizes  
Two-inch sterile gauze pads (8 or 12)  
Three-inch sterile gauze pads (8 or 12)  
Hypoallergenic adhesive tape  
Triangular bandages (3)  
Two-inch sterile roller bandages (3 rolls)  
Three-inch sterile roll bandages (3 rolls)  
Scissor  
Tweezers  
Needle  
Safety razor blade  
Bar of soap  
Moistened towelettes (8-10 individual packages)  
Antiseptic spray  
Thermometer  
Tongue blades and wooden applicator sticks  
Tube of petroleum jelly or other lubricant  
Assorted sizes of safety pins  
Cleansing agent and soap  
Latex gloves

Contact your local American Red Cross chapter to obtain a basic first aid textbook.



### **Non-Prescription Drugs**

- Aspirin or non-aspirin pain reliever
- Anti-diarrhea medication
- Antacid (for stomach upset)
- Laxative
- Eye wash
- Rubbing alcohol
- Emetic (use to induce vomiting if advised)
- Activated charcoal (use if advised by the Poison by the Poison Control Center)
- Antiseptic or hydrogen peroxide

### **SANITATION**

- Toilet paper, towelettes
- Soap, liquid detergent
- Feminine supplies
- Plastic garbage bags, ties
- Plastic bucket with tight lid
- Disinfectant
- Personal items and shampoo, deodorant, toothpaste, tooth brushes; comb and brush; lip balm
- Household chlorine bleach

### **TOOLS AND SUPPLIES**

- Mess kits, or paper cups, plates and plastic utensils
- Emergency preparedness manual
- Battery-operated radio and extra batteries
- Flashlight and extra batteries
- Cash or travelers checks, change
- Non-electric can opener, utility knife
- Fire extinguisher; small canister, ABC type
- Tube tent
- Pliers
- Tape
- Compass
- Matches in a waterproof container
- Aluminum foil
- Plastic storage containers
- Signal flare
- Paper, pencil
- Needles, thread
- Medicine dropper
- Shut-off wrench, to turn off household gas and water
- Whistle
- Plastic sheeting

## CLOTHING AND BEDDING

- Sturdy shoes or work boots
- Rain gear
- One blanket or sleeping bag per person
- Hat and gloves
- Thermal underwear
- Sunglasses

## SPECIAL ITEMS

Remember family members with special needs such as infants, elderly, or disabled individuals.

### For baby

- Formula
- Diapers
- Bottles
- Powdered milk
- Medications
- Extra eye glasses

### For adults

- Heart and high blood pressure medication
- Insulin
- Prescription drugs
- Denture needs
- Contact lenses and supplies

## ENTERTAINMENT

Coloring books, crayons, games for children; books, knitting and other projects for adults.

## IMPORTANT FAMILY DOCUMENTS

- Will, insurance policies, contracts, deeds, stocks and bonds
- Passports, social security cards, immunization records
- Savings and checking account numbers
- Credit card account numbers and companies
- Inventory of valuable household goods, important telephone numbers.
- Family records (birth, marriage, death certificates)

## EMERGENCY CAR KIT

- Battery-powered radio and extra batteries
- Flashlight and extra batteries
- Blankets
- Booster cables
- Fire extinguisher (5 lb. ABC type)
- First aid kit and manual
- Bottled water and non-perishable high energy foods
- Maps
- Shovel
- Tire repair kit
- Flares

# A Citizen's Guide to Disaster Assistance

Excerpts from FEMA Independent Study Course IS-7/October 1999

## How Communities and States Deal with Emergencies and Disasters

During a flood such as Centerville's, many important activities must happen quickly and efficiently. Among these are rescue, caring for the injured, keeping people away from dangerous areas, assessing the situation to see what help is needed, and opening shelters for people displaced from their homes. As all this is occurring, phones are swamped with people asking for information. Without a good plan for such a situation, there would be no hope of getting the job done effectively.

## LOCAL RESPONSE AND RECOVERY ACTIVITIES

Local governments are the first line of defense against emergencies and disasters and are primarily responsible for managing the response to those events. At the local government level, the primary responsibility for protecting citizens belongs to local elected officials such as mayors, city councils, and boards of commissioners. When a local government receives warning that an emergency could be imminent, its first priority is to alert and warn citizens and take whatever actions are needed to minimize damage and protect life and property. If necessary, it may order an evacuation. When an emergency or disaster does occur, fire and police units, emergency medical personnel, and rescue workers rush to damaged areas to provide aid. After this initial response, the local government must work to ensure public order and security. Vital services such as water, power, communications, transportation, shelter, and medical care must be provided, and debris removal must begin. Public and private utility company crews, along with other emergency teams, must be on the job to restore essential services. The local government coordinates its efforts with voluntary agencies who assist individuals and families in need. Since disasters often disrupt water supply lines, local governments must ensure that residents receive drinking water.

When a local government responds to an emergency, the level of the response and the type of resources required are determined by several factors:

- The speed of onset of the emergency.
- The potential need for evacuation.
- The magnitude of the situation.
- The projected duration of the event.
- The extent of the threat to citizens.

In an emergency, local government is responsible for responding to the event in a way that will contain the emergency, protect people and property, meet basic human needs (food, water, shelter, medical care), and minimize damage, as well as for overall management and coordination of an effective response.

## Short-Term and Long-Term Recovery

In the aftermath of an emergency or disaster, many citizens will have specific needs that must be met before they can pick up the thread of their pre-disaster lives. Typically, there will be a need for services such as these:

- Assessment of the extent and severity of damages to homes and other property.
- Restoration of services generally available in communities—water, food, and medical assistance.
- Repair of damaged homes and property.
- Professional counseling when the sudden changes resulting from the emergency have resulted in mental anguish and the inability to cope.

Local governments help individuals and families recover by ensuring that these services are available and by seeking additional resources if the community needs them. Also, when an emergency occurs, the local government uses all available media to publicize the types of assistance available and how to access them.

Recovery occurs in two phases – short term and long-term. Short-term recovery measures are those that are intended to return the community to minimum operating standards. Long-term recovery are those steps taken to return to previous conditions (to the extent possible), combined with improvements that will better protect the community from future disasters. Each phase marks a transition that will enable the community to return to normal and create a safer condition for the future.

Short-term recovery could include making houses habitable so that families can move out of temporary shelters and return to their own homes. Short-term recovery also could involve restoring essential services so people can return to work. At the community level, this part of recovery may require completing repairs to roads and bridges so traffic can start moving again or restoring water and power to areas in need, especially to important public structures such as hospitals and major places of employment. In Centerville, for example, short-term recovery would include all of these activities, with priority given to restoring services in public structures and major places of employment. The restoration of major roads will be given priority to help people return to their homes and work safely; many minor routes may have to wait for repairs.

Long-term recovery may occur over a period of months or years, depending on the severity of the emergency or disaster. It often involves extensive repair and rebuilding. The disruption and destruction to the community can be so great that some businesses may never reopen or may have to relocate. Although a community may appear to be “open for business” a few weeks after an emergency or disaster, it may be years after a severe disaster before the

community returns to pre-disaster conditions. Following a disaster, repairing major roads is a high priority among short-term recovery tasks.

As part of the recovery, communities should consider strategies that would lessen the effects of a similar event in the future. These strategies, called mitigation measures, may have helped lessen the effects in the Centerville flood scenario. During the rebuilding process, residents could raise their furnaces to higher floors, business owners could consider storing inventory in areas above the flood level, and hospitals could elevate and move generators and other critical facilities to protected buildings. In the case of severe and repeated flood damage, residents might consider relocating damaged structures to a safer area. The community of Centerville could begin enforcing more stringent building codes and floodplain ordinances that help structures withstand flooding.

In addition to the self-help efforts of individuals and families and the efforts of local governments in emergencies, voluntary agencies are a central part of the effective response to, and recovery from, an emergency.

### **The Role of Voluntary Agencies**

When most Americans think about disasters, they picture volunteers from agencies such as the American Red Cross and the Salvation Army providing a helping hand to the victims. Voluntary agencies are an essential part of any disaster relief effort, providing critical assistance with food, shelter, clothing, household items, medical expenses, clean-up, repairs, and rebuilding. These agencies are typically involved in all the phases of emergency management (mitigation, preparedness, response, and recovery). Some voluntary agencies are available to respond to emergencies in all communities; others may respond only to disasters that affect specific regional areas. Voluntary agencies respond whether or not there is a Presidential declaration, coordinating with each other and with government officials to meet a community's disaster needs.

### **Requesting State Assistance**

If the situation warrants, the community may have to reach beyond its own boundaries for additional resources. Mutual aid agreements should already be in place to facilitate provision of assistance by neighboring jurisdictions. In our flood scenario, however, these agreements will not result in significant added resources because other communities are also overwhelmed.

In such a case, the local government would have to appeal to the State for assistance. Centerville would seek assistance in transportation and rescue, for example. Local officials will submit a request to the Governor providing specific information about the situation and its effects and specifying the type of assistance needed. The State emergency management office and other offices involved in providing disaster assistance carefully assess this request and advise the Governor on appropriate actions.

Periodically, local officials send reports to the State that convey important

information about the types and levels of assistance that might be required to assist the people in the impacted area. A typical situation report would contain information about the magnitude and severity of damages associated with the disaster event. Deaths, injuries, property damages, and locations in which losses occurred would be described. As additional information becomes available, updated reports are provided. In a flood such as Centerville's, the state might be asked to help rescue stranded people and farm animals.

Generally, State emergency officials work very closely with local officials to ensure that required documentation is included in situation reports. If a request were to be made subsequently for a Presidential declaration (as will be explained in a later unit), the information contained in these reports would be of critical importance. The documentation of the local government's level of effort in responding to the event and the location of areas of damage are especially important.

## STATE RESPONSE AND RECOVERY ACTIVITIES

All states have laws that describe the responsibilities of State government in emergencies and disasters. These laws provide governors and State agencies with the authority to plan for and carry out the necessary actions to respond to emergencies and recover from their effects. Typically, State emergency management legislation describes the duties and powers of the Governor, whose authority typically includes the power to declare a state of emergency and to decide when to terminate this declaration.

Many of the specific responsibilities to carry out the provisions of the State emergency management legislation are generally delegated to the State emergency management organization. Virtually all States have emergency management organizations, although their name and structure may vary from State to State. Typical names include office of emergency services or division of emergency management. Regardless of the title or location of the emergency management organization in the structure of the State government, its responsibilities are the same - to prepare for emergencies and to coordinate the activation and use of the resources controlled by the State government when they are needed to help local governments respond to, and recover from, emergencies and disasters.

The State emergency management organization, in its coordinating role, is involved in virtually all serious emergencies or disasters. Typically, this organization is responsible for receiving reports from the local area. Based on these and other data, emergency management officials work in consultation with other agency representatives and members of the Governor's staff to determine what types of resources and personnel should be deployed to the impacted area. Using procedures specified in the State plan, the State emergency management organization will coordinate deployment of State personnel and resources to the impacted areas.

However, it is not necessary for a Governor to declare an emergency or disaster before agency personnel and resources are deployed to monitor situations and provide information. Personnel and equipment are typically used to monitor situations in which an area's water supply may become contaminated or when large-scale chemical leakage

is possible. State agency personnel would generally be involved in early inspection activities and in making reports back to the emergency management office and their own agencies for the purpose of determining additional assistance that may be needed.

When an emergency is declared, the Governor (or emergency management agency official acting for the Governor) can mobilize resources to supplement their own supplies, equipment, and personnel. In a situation like that of Centerville, for example, in which large populated areas are threatened by the continued rise in floodwaters, the State could assist in evacuation of the threatened area by prescribing evacuation routes and helping to control entries and departures from the disaster area.

State and local government also may regulate the movement of persons inside the affected area; persons can be prevented from returning to buildings rendered uninhabitable or unsafe by the disaster itself. The exercise of these powers could become necessary not only to protect the residents of the affected community but also to make the work of the emergency response personnel safer and more efficient. A governor may declare a state emergency in order to facilitate the deployment of State resources to a disaster area.

In many States, governors can suspend State laws or local ordinances if it is determined that the law in question will restrict or prohibit efforts to relieve human suffering caused by the situation. In some States, after a State emergency declaration, the Governor may establish economic control over resources and services such as food, wages, clothing, and shelter in the affected area.

Under a State emergency declaration, governors typically are empowered to mobilize the National Guard and direct its efforts. Generally, they are granted the power to use all available State resources needed to respond effectively and efficiently to the event. The Governor is able to draw upon the resources, expertise, and knowledge of State agencies as needed to assist in the effort. In many disasters, the States can provide technical assistance and resources that would not be available to most local officials within their own communities.

An affected State also is able to request mutual aid from other States. Though the Emergency Management Assistance Compact (EMAC) or a similar arrangement, participating States agree to provide personnel, equipment, and supplies to another State in need. Mutual aid enables States to draw upon a common pool of resources with minimal Federal involvement.

Under a State emergency declaration, the Governor may also have the power to use or commandeer private property for the purpose of responding to the disaster. Emergency management acts generally grant the Governor the power Under a State emergency declaration, governors typically are empowered to mobilize the National Guard and direct its efforts to use, or authorize the use of, contingency and emergency funds in the event of an emergency. In some States, the Governor also may reallocate funds when designated funds are exhausted.

## Types of Assistance Provided

Typically, there are two types of State response assistance.

- State personnel and resources can be activated and deployed to assist in the response effort directly (or to manage it, in some instances).

Examples of this type of activity include evacuation management, securing the affected area, and search and rescue.

- State personnel and equipment can be deployed to perform a variety of monitoring and inspection activities that can ensure the safety of inhabitants and response personnel in the area.

Examples of these types of activities include the use of officials to monitor threats of chemical and other fires or to monitor the water supply and ensure its continued safety. State officials may periodically inspect structures such as dams, levees, and bridges to monitor their condition and determine whether they are safe for continued use.

If necessary, the State may undertake emergency repairs (such as to restore bridges that are part of an essential route). State officials may inspect structures such as dams, levees, and bridges to determine whether repairs are needed. State assistance to communities is provided by many different State agencies. Typical services provided by some key agencies are described below.

### Department of Public Safety

In many major floods - such as the one depicted in the scenario - bridges often are damaged, and very heavy debris may clog up the river, creating a more serious threat to surrounding areas. Heavy cranes and other equipment, along with the expertise and skill needed to use the equipment, can often be provided by State transportation or highway agencies. Engineers employed by transportation departments also have the knowledge and skills to conduct accurate damage assessments of bridges and other structures. In addition, they can suggest mitigation methods so that reconstruction includes added protection for future disasters.

State public safety personnel can assist in law enforcement for disaster areas, traffic control (especially in evacuation and for incoming assistance), security (such as to protect evacuated homes and businesses from looting and further damage), and search and rescue. The fire marshal's office can deploy personnel to investigate structural fires and to assist in assessing the safety of structures that may be at risk from fires. State public safety officials may assist in search and rescue operations.

Public health units within the public safety department often must perform tasks such as water supply monitoring, food supply inspection, and communicable disease control. State specialists also may assist in documenting (videotaping) damage.



### **Social Service Agencies**

State social service agencies can provide or fund personnel and resources to assist in the management of shelters and to provide assistance to individuals and families. This can include counseling to alleviate stress, which, experience has demonstrated, must be handled appropriately in the early phases of a disaster to minimize later negative effects of the experience. If there is a Presidential declaration, these are usually the agencies that provide administrative services to manage the Individual and Family Grant Program. These agencies also are usually assigned to assist voluntary agencies such as the American Red Cross in their efforts to provide relief to disaster victims.

### **The National Guard**

In a flood as serious as the one described in the scenario, the State National Guard could send personnel who could be assigned a wide range of duties. They would assist in flood-fighting activities such as sandbagging, evacuation, and search and rescue. The National Guard is frequently assigned to maintain order and civil control and to provide supplemental law enforcement and fire suppression assistance.

The National Guard units also have other valuable resources and equipment that can be used: trucks, helicopters, heavy tools and equipment, portable medical facilities, mobile kitchens, and communications equipment.

### **Public Health Agencies**

State public health agencies perform several important functions in response and recovery. These agencies can make available: physicians, nurses, epidemiologists, medical technicians, and others. Equipment and facilities also are provided.

Monitoring water supplies, inspecting food supplies, controlling communicable diseases, providing and allocating medication in disaster-impacted areas, monitoring health care facilities, and identifying victims are among the more important response and short-term recovery activities that can be provided by, or coordinated through, State public health agencies.

### **Department of Agriculture**

The State's department of agriculture will generally assist when damage to farms and ranches is involved. It often carries out measures to protect the long-term food supply of the affected area. State agriculture departments also inventory food resources and may help procure food for disaster victims. Longer-term assistance provided by agriculture departments includes advising farmers and agribusinesses in mitigation planning and recovering from damages to facilities, crops, and livestock.

### **Natural Resource Agencies**

Natural resource agencies have several types of expertise useful to an effective response, including fire suppression and the protection of fish and game resources. Natural resource agencies may have personnel available to assist in conducting damage assessments. Also, these agencies advise local officials and help them monitor and protect natural resources such as fish and game, as well as wild lands and other protected areas. Environmental protection agencies may assist in similar ways to help local officials preserve and protect various environmentally sensitive areas and to plan mitigation measures for disasters. They can also provide technical expertise to help agencies respond appropriately to hazardous materials spills that could result from primary events such as floods. State natural resource agencies may be able to contribute expertise when natural resources are threatened by fire.

## Other Resources

Other State agencies have resources and expertise helpful to local communities stricken by disaster. For example, labor departments can assist with immediate safety inspections. Education departments can help maintain education services. State management and budget agencies can assist in locating and establishing recovery centers and field operations offices.

Depending upon the severity of the disaster and the damages, some agencies - such as offices of management and budget, labor, employment security, commerce, and treasury—become more substantially involved in providing assistance for the community's recovery. For example, treasury departments can conduct post-emergency audits to document expenditures by local governments. In some States, they also provide tax advice for disaster victims. Some State general services agencies can help identify and make available State facilities and related equipment to be used for shelter, as well as for the warehousing of food supplies or other resources.

In most States, commerce departments assist in licensing motor carriers and other vehicles needed to transport supplies. They also work to expedite and prioritize the recovery of utilities to the affected areas. Personnel from these agencies also may be involved in damage assessment work.

Finally, a key activity of State emergency offices is to review and critique the State's effort, with the objective of strengthening the State's response in the event of another disaster.

## THE ROLE OF PLANNING IN DISASTER ASSISTANCE

The ability of communities and States to respond effectively to disasters depends largely on actions taken before the disaster. Communities and States should develop both response and hazard mitigation plans. Officials plan what roles different organizations would have in a disaster and how they would coordinate with each other to avoid duplication of benefits or confusion.

### Response Planning

The community's ability to respond to an emergency begins with the development of a local emergency operations plan.

Each community's plan may include a list of resources the community would use for various types of emergencies. In a flood such as Centerville's, for example, the local government will contact technical experts who can assess the condition of the flood protection structures and analyze the implications of their condition for flood control. The community's advance planning should also identify what routes could be used to evacuate people quickly in the event of a disaster. In Centerville's case, since the area has always been vulnerable to flooding, these would be pre-selected to facilitate movement. Shelter locations would also be identified as a preparedness measure.

The plan also establishes ways to notify the public in the event of an emergency. In our scenario, electric power was lost in Centerville, so many people could not get information either by phone or by television. The area did not have a siren warning system, and evacuation routes were not generally familiar to the public. As a result, the only means of reaching many people was through broadcasts that could be received only on battery-operated radios or by traveling to their neighborhoods.

Where did Centerville get the boats it used to rescue its citizens? Unless the town had worked out an advance agreement with possible sources, it lost valuable time trying to make the necessary arrangements at the time of immediate need. In addition to making arrangements with private sources to borrow resources (such as heavy equipment that may be needed for debris removal), communities may also have mutual aid agreements in place with adjacent communities to facilitate requests for assistance.

In addition to providing policies, procedures, and an emergency organization structure, the plan contains information on the specific emergency conditions under which the plan will be activated. If the conditions warrant, local authorities may declare an emergency. The legal basis for a local state-of-emergency declaration typically is a local ordinance that stipulates who has the authority to declare a state of emergency and under what conditions this can be done. Documentation provided in the plan gives local governments a solid legal foundation for any subsequent request for State and Federal emergency assistance and eliminates any confusion about the degree of impact the event has had on the community. Communities that formulate sound plans, establish appropriate emergency related policies, and test their plans through regularly scheduled exercises will be prepared to assist citizens if an emergency occurs.

State governments also must document their plans for emergency response. The typical State plan is similar in structure and organization to most emergency operations plans developed by local governments. State and local plans should be coordinated to ensure that procedures for providing assistance result in an effective combined effort.

Community plans should specify sources for the heavy equipment needed for debris removal.

### **State and Local Hazard Mitigation Planning**

The Stafford Act requires that the recipients of disaster assistance make every effort to mitigate the natural hazards in the area. To comply with this provision, State and local governments must prepare and implement a hazard mitigation plan outlining cost-effective strategies to reduce vulnerability to specific hazards. Through the plan, State and local government can:

- Evaluate the hazards in the disaster area.
- Identify appropriate actions to mitigate vulnerability to these hazards.

The Stafford Act specifically encourages regulation of land use and protective construction standards as part of a long-term, comprehensive approach to mitigation. The President is also authorized to prescribe hazard mitigation standards and approve such standards proposed by State and local governments. Disaster assistance can be made conditional upon a recipient's agreement to develop a long-term strategy and program that will reduce or eliminate the need for future Federal disaster assistance should a similar event recur.

## **REQUESTING FEDERAL ASSISTANCE**

What if the available resources and personnel of both the local and State governments are inadequate to meet the response and recovery needs created by the disaster? The local government or State officials may at any time request assistance directly from a number of Federal agencies, most of which can provide some form of direct assistance without a Presidential declaration. When a disaster situation is beyond the capabilities of local and State resources, even as supplemented by private and voluntary agencies and by direct assistance from Federal agencies, the Governor may ask the President to declare a major disaster. If granted, supplemental disaster assistance is made available to help individuals, families, and the community.

## **EARLY IMPLEMENTATION STRATEGY FOR HAZARD MITIGATION**

After a Presidential disaster declaration, FEMA works with the State to develop an Early Implementation Strategy. The strategy outlines activities to help reduce future damages based on damages assessed in the current disaster. This ensures that communities, States, and individuals consider ways to reduce potential damages from the next disaster as they make repairs now.

## **SUMMARY**

Local governments are the first line of defense against emergencies. When needed, they serve as the link between individuals and the emergency response and recovery efforts carried out by State and Federal government.

Response involves immediate actions to save lives, protect property, and meet basic human needs. Short-term recovery generally involves temporary measures to restore essential services and get the community going again. Long-term recovery involves permanent restoration, including steps to provide greater safety for the future. Local ordinances and emergency operations plans are the basis for the local response effort. Voluntary agencies are an integral part of the community response effort.

The local government requests State assistance when it is needed. The State uses local reports describing damages incurred and local actions taken to determine how to best direct its resources.

If the State's resources are also overwhelmed, the Governor may request specific types of assistance from the Federal government.